

ICF-C243

SERVICE MANUAL

US Model
Canadian Model



DREAM MACHINE

TABLE OF CONTENTS

<i>Section</i>	<i>Title</i>	<i>Page</i>
	Features	2
	Specifications	2
1. GENERAL		
1-1.	Location of Controls	3
2. DIAL POINTER SETTING	3
3. ELECTRICAL ADJUSTMENTS	4
4. DIAGRAMS		
4-1.	Printed Wiring Board	5
4-2.	Schematic Diagram	7
5. EXPLODED VIEW	9
6. ELECTRICAL PARTS LIST	10

FM/AM CLOCK RADIO
SONY®

Features



- Dual alarm
- Date display
- Forward/reverse time setting
- Full power backup to keep the clock and the alarm (radio and buzzer) during a power interruption with a 6F22 battery (not supplied) installed.

Specifications

Frequency range: FM: 87.6 – 108 MHz
 AM: 530 – 1,610 kHz
Speaker: Approx. 6.6 cm (2 5/8 inches) dia.
Power output: 90 mW (at 10 % harmonic distortion)
Power requirements:
 120 V AC, 60 Hz
 For power backup: 9 V DC, one 6F22 battery
Battery life: Approx. 35 hours using the Sony S-006P(U) battery
Dimensions: Approx. 210 × 58 × 153 mm (w/h/d)
 (8 3/8 × 2 3/8 × 6 1/8 inches) incl. projecting parts and controls
Mass: Approx. 600 g (1lb 5oz) not incl. battery

Design and specifications are subject to change without notice.

SAFETY-RELATED COMPONENT WARNING!!

COMPONENTS IDENTIFIED BY MARK  OR DOTTED LINE WITH MARK  ON THE SCHEMATIC DIAGRAMS AND IN THE PARTS LIST ARE CRITICAL TO SAFE OPERATION. REPLACE THESE COMPONENTS WITH SONY PARTS WHOSE PART NUMBERS APPEAR AS SHOWN IN THIS MANUAL OR IN SUPPLEMENTS PUBLISHED BY SONY.

Note :

HOW TO CHANGED THE CERAMIC FILTERS

This model is used two ceramic filters of CF1, CF3. You must used same type of color marked ceramic filters in order to meet same specifications. Therefore, the ceramic filter must changed two pieces together since it's supply two pieces in one package as a spare parts.

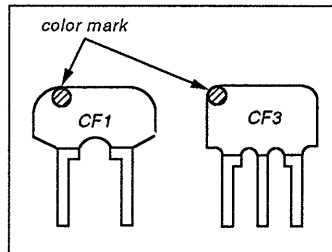
	color mark	center frequency
	red	10.70MHz
	blue	10.67MHz
	orange	10.73MHz

SECTION 1 GENERAL

This section is extracted from instruction manual.

1-1. LOCATION OF CONTROLS

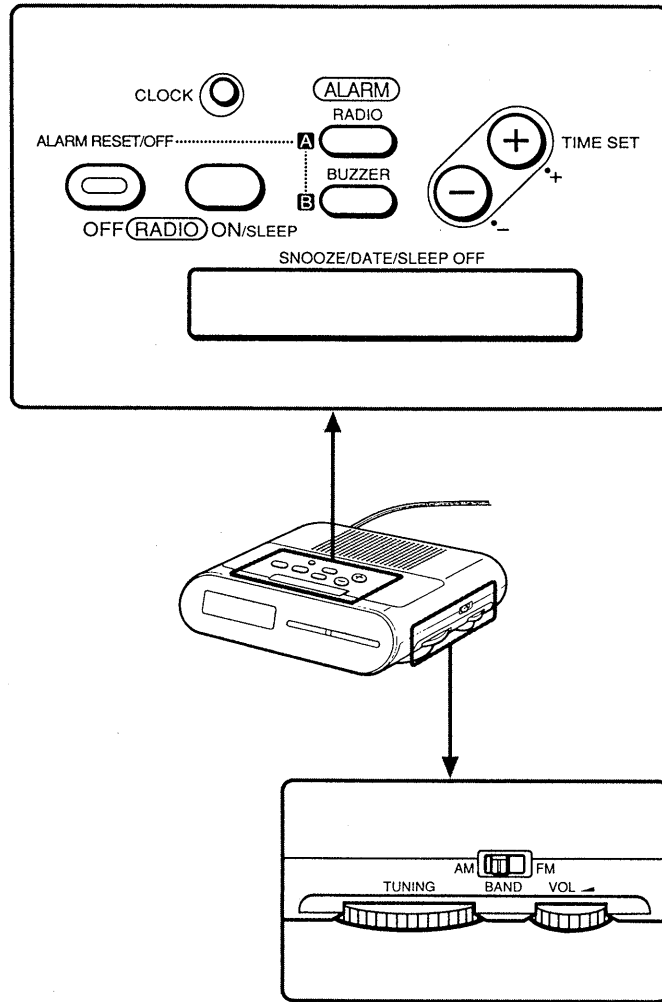

SECTION 2 DIAL POINTER SETTING

DIAL POINTER SETTING

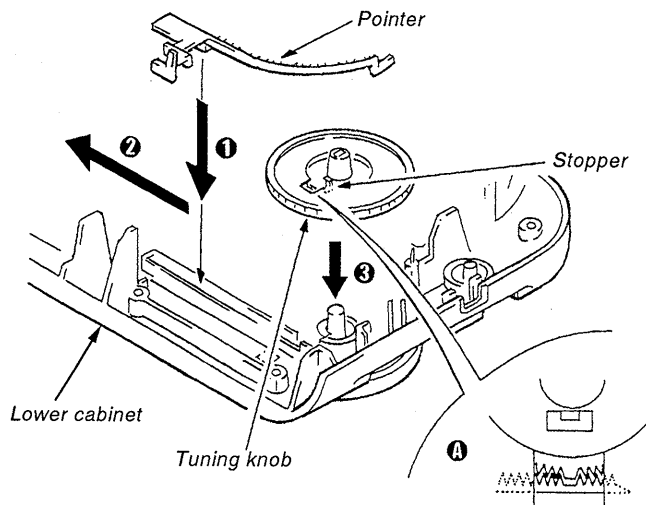

- ① Fit the gear part of pointer to cabinet groove.
- ② Move pointer in the direction of arrow fully.
- ③ Install the gear part of stopper and the gear part of pointer as show in the drawing A. Make sure to fit the stopper to the cabinet hole.

SECTION 3 ELECTRICAL ADJUSTMENTS

AM Section

Setting :

BAND switch : AM

AM RF signal generator

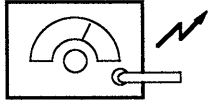

Put the lead-wire antenna close to the set.

30% amplitude modulation by 400Hz signal.
Output level : as low as possible

FM Section

Setting :

BAND switch : FM

FM RF signal generator

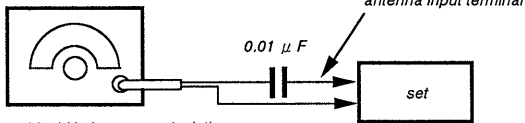

± 22.5kHz frequency deviation by 400Hz signal.
Output level : as low as possible

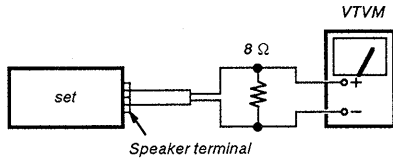

- Repeat the procedures in each adjustment several times, and the frequency coverage and tracking adjustments should be finally done by the trimmer capacitors.

Adjustment Location :

[MAIN BOARD] – Component side –

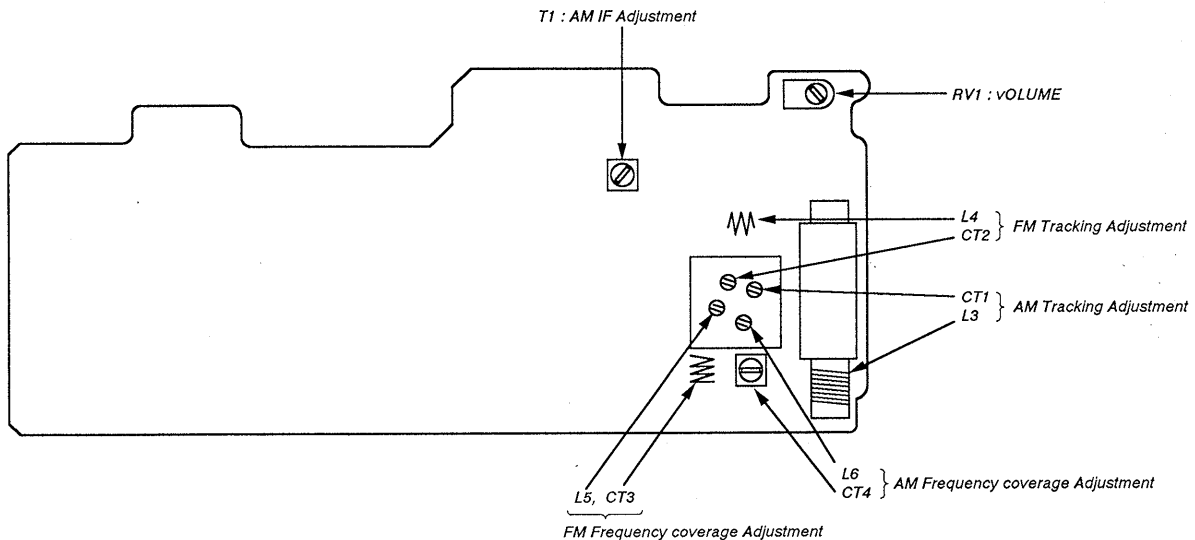

AM IF ADJUSTMENT	
Adjust for a maximum reading on VTVM.	
T1	455kHz

AM FREQUENCY COVERAGE ADJUSTMENT	
Adjust for a maximum reading on VTVM.	
L6	520kHz
CT4	1,650kHz

AM TRACKING ADJUSTMENT	
Adjust for a maximum reading on VTVM.	
L3	680kHz
CT1	1,320kHz

FM FREQUENCY COVERAGE ADJUSTMENT	
Adjust for a maximum reading on VTVM.	
L5	86.5MHz
CT3	109.5MHz

FM TRACKING ADJUSTMENT	
Adjust for a maximum reading on VTVM.	
L4	86.5MHz
CT2	109.5MHz

SECTION 4
DIAGRAMS

4-1. PRINTED WIRING BOARD

● SEMICONDUCTOR LOCATION

Ref. No.	Location
D3	D-5
D4	C-5
D5	E-8
D6	E-7
D7	C-4
D8	C-6
D9	C-5
D10	F-6
IC1	D-3
IC2	D-6
Q1	D-3
Q2	D-4
Q3	C-4

● Semiconductor Lead Layout

CXA1019S
LC85631

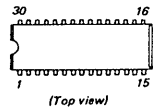

UZ-4.7BSC
1SS119

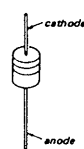

2SA1175-HFE

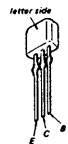

10E2

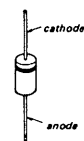

2SC2001-LK

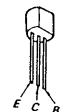

Note:

○ : parts extracted from the component side.

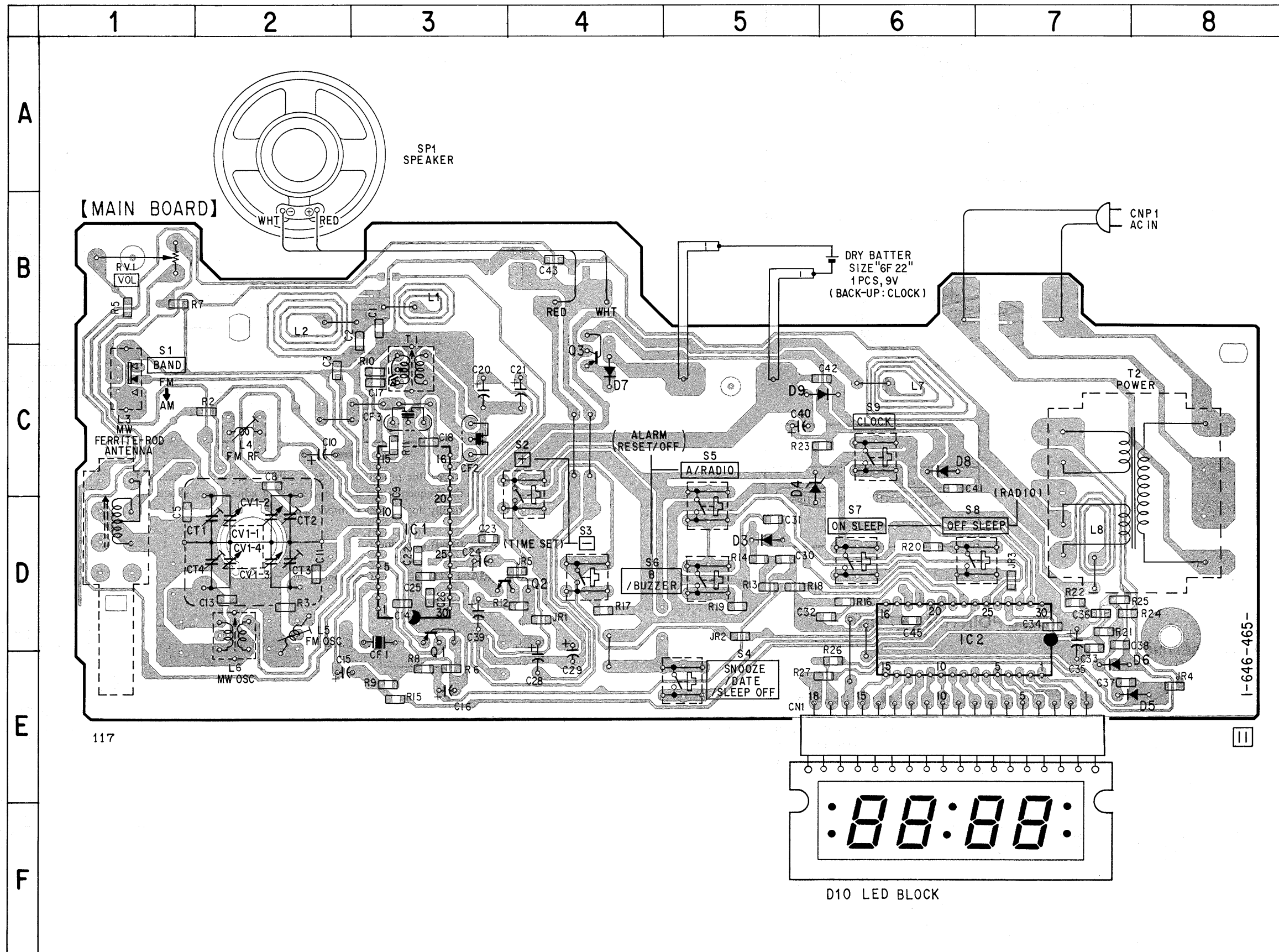

117

I-646-465

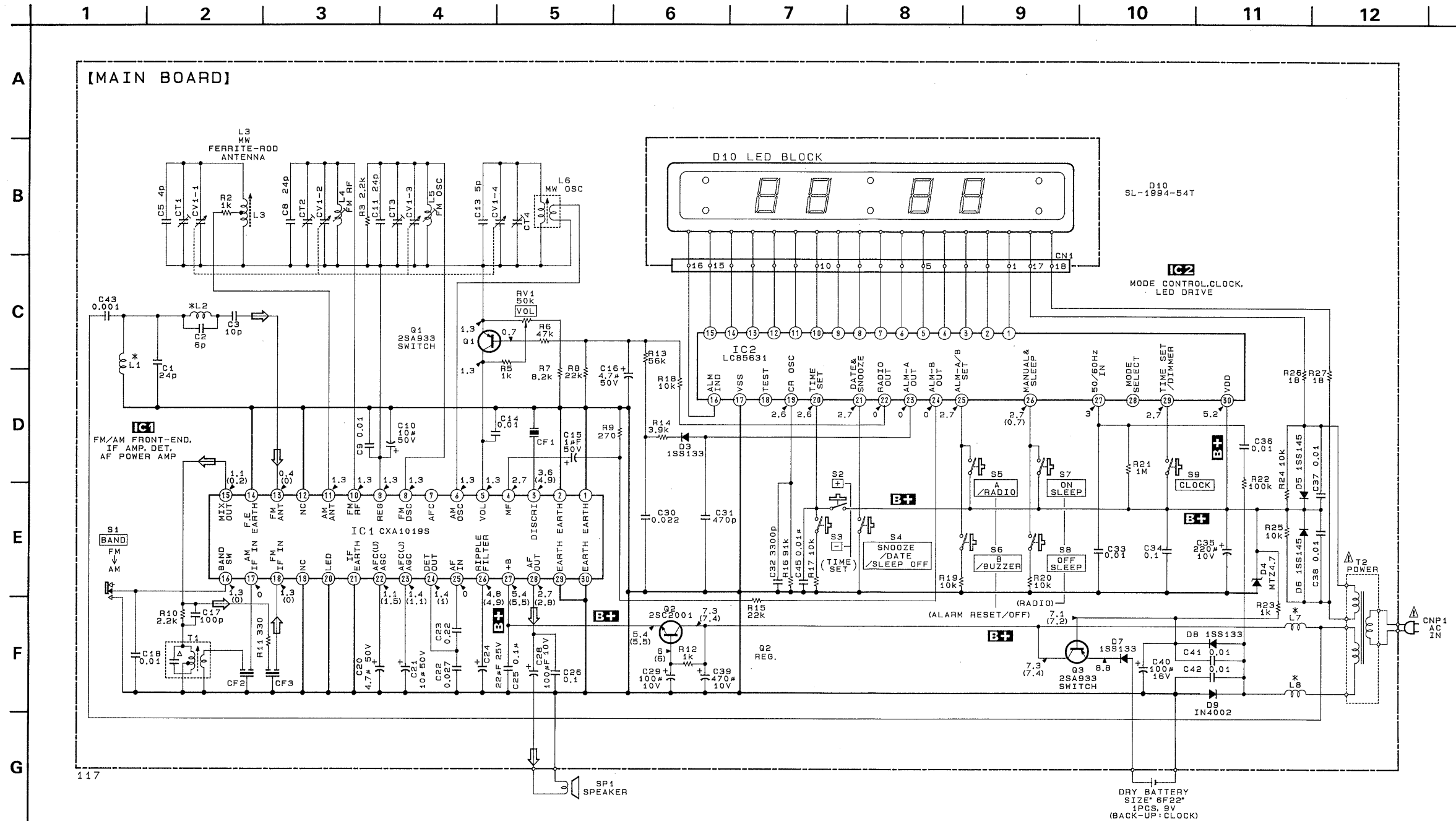

● IC BLOCK DIAGRAM

IC1 CXA1019S

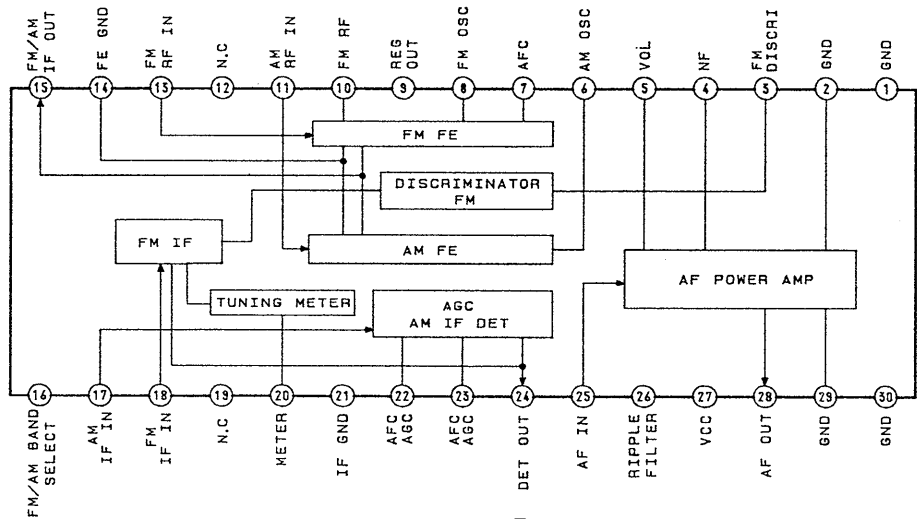

Note :

- All capacitors are in μF unless otherwise noted. pF: $\mu \mu F$ 50WV or less are not indicated except for electrolytics and tantalums.
- All resistors are in Ω and $\frac{1}{4}W$ or less unless otherwise specified.
- Δ : internal component.

Note : The components identified by mark Δ or dotted line with mark Δ are critical for safety. Replace only with part number specified.

• **B+** : B+ Line

• Voltage and waveforms are dc with respect to ground under no-signal (detuned) conditions.

no mark : FM
() : AM

• Voltages are taken with a VOM (Input impedance $10M \Omega$). Voltage variations may be noted due to normal production tolerances.

• Signal path.
 \Rightarrow : FM

• * : printed pattern functions as a kind of coil.

MAIN

SECTION 6 ELECTRICAL PARTS LIST

NOTE:

- Due to standardization, replacements in the parts list may be different from the parts specified in the diagrams or the components used on the set.
- -XX and -X mean standardized parts, so they may have some difference from the original one.
- RESISTORS
All resistors are in ohms.
METAL: Metal-film resistor.
METAL OXIDE: Metal oxide-film resistor.
F: nonflammable

- Items marked "*" are not stocked since they are seldom required for routine service. Some delay should be anticipated when ordering these items.
- SEMICONDUCTORS
In each case, u: μ , for example:
uA ..: μ A.. uPA..: μ PA..
uPB..: μ PB.. uPC..: μ PC.. uPD..: μ PD..
• CAPACITORS
uF: μ F
- COILS
uH: μ H

The components identified by mark Δ or dotted line with mark Δ are critical for safety. Replace only with part number specified.

When indicating parts by reference number, please include the board.

Ref. No.	Part No.	Description	Remark
*	A-3679-477-A	MAIN BOARD, COMPLETE ***** < CAPACITOR >	
C1	1-163-102-00	CERAMIC CHIP 24PF	5% 50V
C2	1-163-089-00	CERAMIC CHIP 6PF	50V
C3	1-163-093-00	CERAMIC CHIP 10PF	5% 50V
C5	1-163-087-00	CERAMIC CHIP 4PF	50V
C8	1-163-102-00	CERAMIC CHIP 24PF	5% 50V
C9	1-164-232-11	CERAMIC CHIP 0.01uF	50V
C10	1-124-907-11	ELECT 10uF	20% 50V
C11	1-163-362-11	CERAMIC CHIP 24PF	5% 50V
C13	1-163-088-00	CERAMIC CHIP 5PF	50V
C14	1-163-031-11	CERAMIC CHIP 0.01uF	50V
C15	1-124-903-11	ELECT 1uF	20% 50V
C16	1-124-927-11	ELECT 4.7uF	20% 100V
C17	1-163-117-00	CERAMIC CHIP 100PF	5% 50V
C18	1-163-031-11	CERAMIC CHIP 0.01uF	50V
C20	1-124-927-11	ELECT 4.7uF	20% 100V
C21	1-124-907-11	ELECT 10uF	20% 50V
C22	1-163-986-00	CERAMIC CHIP 0.027uF	10% 25V
C23	1-164-222-11	CERAMIC CHIP 0.22uF	25V
C24	1-126-233-11	ELECT 22uF	20% 50V
C25	1-164-004-11	CERAMIC CHIP 0.1uF	10% 25V
C26	1-164-004-11	CERAMIC CHIP 0.1uF	10% 25V
C28	1-124-443-00	ELECT 100uF	20% 10V
C29	1-124-443-00	ELECT 100uF	20% 10V
C30	1-163-033-00	CERAMIC CHIP 0.022uF	50V
C31	1-163-133-00	CERAMIC CHIP 470PF	5% 50V
C32	1-164-182-11	CERAMIC CHIP 0.0033uF	10% 50V
C33	1-164-232-11	CERAMIC CHIP 0.01uF	50V
C34	1-163-038-00	CERAMIC CHIP 0.1uF	25V
C35	1-126-176-11	ELECT 220uF	20% 10V
C36	1-164-232-11	CERAMIC CHIP 0.01uF	50V
C37	1-163-031-11	CERAMIC CHIP 0.01uF	50V
C38	1-163-031-11	CERAMIC CHIP 0.01uF	50V
C39	1-124-472-11	ELECT 470uF	20% 10V
C40	1-126-101-11	ELECT 100uF	20% 16V
C41	1-163-031-11	CERAMIC CHIP 0.01uF	50V
C42	1-163-031-11	CERAMIC CHIP 0.01uF	50V
C43	1-163-025-11	CERAMIC CHIP 0.001uF	50V
C45	1-163-031-11	CERAMIC CHIP 0.01uF	50V

Ref. No.	Part No.	Description	Remark
		< FILTER >	
CF1	1-567-097-61	FILTER, CERAMIC	
CF2	1-577-072-11	FILTER, CERAMIC	
CF3	1-567-097-61	FILTER, CERAMIC	
		< CONNECTOR >	
CN1	1-696-939-11	CORD, CONNECTION (18 CORE)	
		< VARIABLE CAPACITOR >	
CV1-4	1-151-628-11	CAP, VARIABLE	
CT1-4			
		< DIODE >	
D3	8-719-911-19	DIODE 1SS119	
D4	8-719-010-34	DIODE UZ-4.7BSC	
D5	8-719-911-19	DIODE 1SS119	
D6	8-719-911-19	DIODE 1SS119	
D7	8-719-911-19	DIODE 1SS119	
D8	8-719-911-19	DIODE 1SS119	
D9	8-719-200-02	DIODE 10E-2	
D10	1-810-026-11	DIODE SL-1994-54T	
		< IC >	
IC1	8-752-035-29	IC CXA1019S	
IC2	8-759-095-52	IC LC85631	
		< JUMPER RESISTOR >	
JR1	1-216-295-00	METAL CHIP 0 5% 1/10W	
JR2	1-216-295-00	METAL CHIP 0 5% 1/10W	
JR3	1-216-295-00	METAL CHIP 0 5% 1/10W	
JR4	1-216-295-00	METAL CHIP 0 5% 1/10W	
JR5	1-216-295-00	METAL CHIP 0 5% 1/10W	
		< COIL >	
L3	1-402-413-21	ANTENNA, FERRITE-ROD (MW)	
L4	1-402-986-11	COIL, AIR-CORE	
L5	1-428-163-11	COIL, AIR-CORE	
L6	1-406-028-00	COIL, OSC (MW)	

Ref. No.	Part No.	Description	Remark
< TRANSISTOR >			
Q1	8-729-119-76	TRANSISTOR 2SA1175-HFE	
Q2	8-729-142-46	TRANSISTOR 2SC2001-LK	
Q3	8-729-119-76	TRANSISTOR 2SA1175-HFE	
< RESISTOR >			
R2	1-216-049-00	METAL CHIP 1K 5% 1/10W	
R3	1-216-057-00	METAL CHIP 2.2K 5% 1/10W	
R5	1-216-049-00	METAL CHIP 1K 5% 1/10W	
R6	1-216-089-00	METAL CHIP 47K 5% 1/10W	
R7	1-216-071-00	METAL CHIP 8.2K 5% 1/10W	
R8	1-216-081-00	METAL CHIP 22K 5% 1/10W	
R9	1-216-035-00	METAL CHIP 270 5% 1/10W	
R10	1-216-057-00	METAL CHIP 2.2K 5% 1/10W	
R11	1-216-037-00	METAL CHIP 330 5% 1/10W	
R12	1-216-049-00	METAL CHIP 1K 5% 1/10W	
R13	1-216-091-00	METAL CHIP 56K 5% 1/10W	
R14	1-216-063-00	METAL CHIP 3.9K 5% 1/10W	
R15	1-216-081-00	METAL CHIP 22K 5% 1/10W	
R16	1-216-096-00	METAL GLAZE 91K 5% 1/10W	
R17	1-216-073-00	METAL CHIP 10K 5% 1/10W	
R18	1-216-073-00	METAL CHIP 10K 5% 1/10W	
R19	1-216-073-00	METAL CHIP 10K 5% 1/10W	
R20	1-216-073-00	METAL CHIP 10K 5% 1/10W	
R21	1-216-121-00	METAL CHIP 1M 5% 1/10W	
R22	1-216-097-00	METAL CHIP 100K 5% 1/10W	
R23	1-216-049-00	METAL CHIP 1K 5% 1/10W	
R24	1-216-073-00	METAL CHIP 10K 5% 1/10W	
R25	1-216-073-00	METAL CHIP 10K 5% 1/10W	
R26	1-216-007-00	METAL CHIP 18 5% 1/10W	
R27	1-216-007-00	METAL CHIP 18 5% 1/10W	
< VARIABLE RESISTOR >			
RV1	1-228-790-00	RES, VAR, CARBON 50K (VOL)	
< SWITCH >			
S1	1-571-478-11	SWITCH, SLIDE (BAND)	
S2	1-554-937-11	SWITCH, KEY BOARD TIME SET (+)	
S3	1-554-937-11	SWITCH, KEY BOARD TIME SET (-)	
S4	1-554-937-11	SWITCH, KEY BOARD (SNOOZE/DATE/SLEEP OFF)	
S5	1-554-937-11	SWITCH, KEY BOARD (A/RADIO (ALARM RESET/OFF))	
S6	1-554-937-11	SWITCH, KEY BOARD (B/BUZZER (ALARM RESET/OFF))	
S7	1-554-937-11	SWITCH, KEY BOARD (ON SLEEP (RADIO))	
S8	1-554-937-11	SWITCH, KEY BOARD (OFF SLEEP (RADIO))	
S9	1-554-937-11	SWITCH, KEY BOARD (CLOCK)	

Ref. No.	Part No.	Description	Remark
< TRANSFORMER >			
T1	1-404-341-00	TRANSFORMER, IF	
<u>△</u> T2	1-449-801-21	TRANSFORMER, POWER	

MISCELLANEOUS *****			
<u>△</u> CNP1	1-696-008-11	CORD, POWER	
SP1	1-503-082-00	SPEAKER	

ACCESSORIES & PACKING MATERIALS *****			
*	3-384-327-01	INDIVIDUAL CARTON (US)	
	3-756-517-21	MANUAL, INSTRUCTION (ENGLISH) (US)	
	3-756-517-31	MANUAL, INSTRUCTION (ENGLISH, FRENCH) (Canadian)	
*	3-917-117-01	INDIVIDUAL CARTON (Canadian)	

***** HARDWARE LIST *****			
#1	7-685-650-79	SCREW +P 3X16 TYPE2 NON-SLIT	
#2	7-685-647-79	SCREW +P 3X10 TYPE2 NON-SLIT	

The components identified by mark △ or dotted line with mark △ are critical for safety. Replace only with part number specified.

Sony Corporation
Consumer A&V Products Company
Personal A&V Products Div.

9-957-688-12

English
94F02059-1
Printed in Japan
© 1994.6
Published by Home A&V Products Div.
Quality Engineering Dept.