

# ICF-C303

## SERVICE MANUAL

US Model  
Canadian Model  
AEP Model  
E Model  
Australian Model



### SPECIFICATIONS

Frequency range	US, CND, E92 model FM: 87.5—108MHz AM: 530—1,710kHz EXCEPT US, CND, E92 model FM: 87.5—108MHz AM: 531—1,602kHz
Scan step	US, CND, E92 model FM: 0.1MHz (fixed) AM: 10kHz (fixed) EXCEPT US, CND, E92 model FM: 0.05*MHz (fixed) AM: 9kHz (fixed) *The frequency display is raised or lowered by steps of 0.1MHz. (Example: Frequency 88.05MHz is displayed as "88.0MHz".)
Antennas	FM: FM wire antenna AM: Built-in ferrite bar antenna
Speaker	Approx. 6.6cm (2 <sup>1</sup> / <sub>8</sub> inches) dia.
Power output	200mW (at 10% harmonic distortion)
Power requirements	US, CND, E92 model: 120V AC, 60Hz AUS model: 240V AC, 50Hz IT, AEC, AEZ, E91 model: 220—230V AC, 50Hz
Dimensions	Approx. 201×61.5×156mm (w/h/d) (8×2 <sup>1</sup> / <sub>2</sub> ×6 <sup>1</sup> / <sub>4</sub> inches) incl. projecting parts and controls
Weight	Approx. 700g (12oz)
Accessory supplied	FM antenna coupler (1) (Netherlands, Denmark, Sweden, Finland, Norway and Austria only)

Design and specifications subject to change without notice.

#### Note

This appliance conforms with EEC Directive 87/308/EEC regarding interference suppression.

### FEATURES

- Dual alarm FM/AM PLL (phase locked loop) synthesized clock radio.
  - Choice of radio alarm or buzzer alarm for both ALARM **A** and **B**.
  - You can wake up by two different stations on ALARM **A** and **B**.
  - You can cancel the alarm for selected days of the week, using the ALARM CANCEL button.
  - REPEAT ALARM/DATE bar (DREAM BAR DATE/SNOOZE for the North and South America model) offers you to enjoy not only the snooze alarm function but also enables you to check the month, day, and day of the week.
  - Choice of four durations for sleep timer: 90, 60, 30, or 15 minutes.
  - You can preset 7 FM/AM stations for easier tuning.
  - LCD display with backlight.
  - Self power backup:  
The built-in capacitor enables the unit to keep the memorized time and frequency for six hours without battery.
- 
- CND: Canadian model
  - IT: Italian model
  - AUS: Australian model
  - AEC: North European model
  - E92: Central and South America model

DUAL ALARM FM/AM PLL  
SYNTHESIZED CLOCK RADIO  
**SONY**®

## SAFETY CHECK-OUT

After correcting the original service problem, perform the following safety check before releasing the set to the customer:

Check the antenna terminals, metal trim, "metallized" knobs, screws, and all other exposed metal parts for AC leakage. Check leakage as described below.

### LEAKAGE TEST

The AC leakage from any exposed metal part to earth ground and from all exposed metal parts to any exposed metal part having a return to chassis, must not exceed 0.5 mA (500 microampers). Leakage current can be measured by any one of three methods.

1. A commercial leakage tester, such as the Simpson 229 or RCA WT-540A. Follow the manufacturers' instructions to use these instruments.
2. A battery-operated AC milliammeter. The Data Precision 245 digital multimeter is suitable for this job.
3. Measuring the voltage drop across a resistor by means of a VOM or battery-operated AC voltmeter. The "limit" indication is 0.75 V, so analog meters must have an accurate low-voltage scale. The Simpson 250 and Sanwa SH-63Trd are examples of a passive VOM that is suitable. Nearly all battery operated digital multimeters that have a 2V AC range are suitable. (See Fig. A)

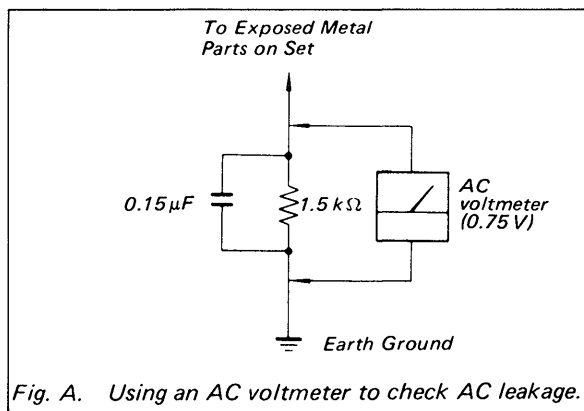
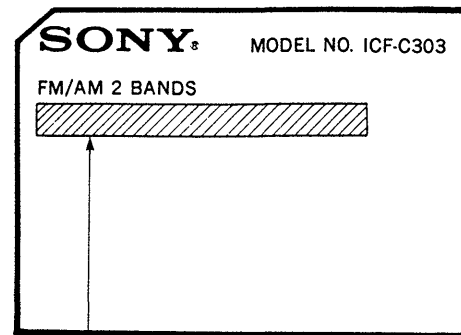

Fig. A. Using an AC voltmeter to check AC leakage.

### MODEL IDENTIFICATION



—Specification Label—



US, CND, E92 model: AC: 120V 60Hz 3W  
 AUS model: AC: 240V~50Hz 3W  
 AEC, AEZ, IT, E91 model: AC: 220~230V~50Hz 3W

- CND: Canadian model
- IT: Italian model
- AUS: Australian model
- AEC: North European model
- E92: Central and South America model

### SAFETY-RELATED COMPONENT WARNING!!

COMPONENTS IDENTIFIED BY MARK  OR DOTTED LINE WITH MARK  ON THE SCHEMATIC DIAGRAMS AND IN THE PARTS LIST ARE CRITICAL TO SAFE OPERATION. REPLACE THESE COMPONENTS WITH SONY PARTS WHOSE PART NUMBERS APPEAR AS SHOWN IN THIS MANUAL OR IN SUPPLEMENTS PUBLISHED BY SONY.

### ATTENTION AU COMPOSANT AYANT RAPPORT À LA SÉCURITÉ!

LES COMPOSANTS IDENTIFIÉS PAR UNE MARQUE  SUR LES DIAGRAMMES SCHÉMATIQUES ET LA LISTE DES PIÈCES SONT CRITIQUES POUR LA SÉCURITÉ DE FONCTIONNEMENT. NE REMPLACER CES COMPOSANTS QUE PAR DES PIÈCES SONY DONT LES NUMÉROS SONT DONNÉS DANS CE MANUEL OU DANS LES SUPPLÉMENTS PUBLIÉS PAR SONY.

# SECTION 1 GENERAL

## How to Set the Date and Time

- Connect the AC power cord to a wall outlet. Figures appear in the display window and begin to flash.
- Open the SLIDE cover.
- Press the DATE/CLOCK button once. MONTH and DAY figures appear and the indication MON (Monday) starts to flash.
- Press the appropriate station/day preset button (MON—SUN) to set the day of the week. You can also set the day of the week by pressing the TUNE/TIME SET + or - button. The + button advances the day and the - button reverses the day.
- Press the DATE/CLOCK button a second time. The day of the week indication stops to flash and the MONTH-DAY indication starts to flash.
- Press the TUNE/TIME SET + or - button to set the date. The + button advances the month and day digits and the - button reverses them. Keep the TUNE/TIME SET + or - button pressed to advance or reverse the month and day digits rapidly.
- Press the DATE/CLOCK button a third time. The MONTH/DAY indication disappears and the time indication appears.
- Adjust the clock to the current time with the TUNE/TIME SET + or - button. The + button advances the hour and minute digits and the - button reverses them. Keep the + or - button pressed to advance or reverse the hour/minute digits rapidly. AM 12:00 = midnight PM 12:00 = noon
- Press the DATE/CLOCK button again. You hear two beeps. The day of the week, month, day and time have been set and only the time indication remains in the display window.
- Close the SLIDE cover. Zero second adjustment Example: To set to 8:15 AM 1 Follow the steps as previously described in 1 to 7. 2 Adjust the time to 8:15 AM. 3 Press the DATE/CLOCK button with the radio or telephone time signal.

To check the day of the week, and the date, Press the DREAM BAR DATESNOOZE bar. The day of the week and the date indication appears in the display window.

This section is extracted from instruction manual.

## Location of Controls

(1) SLIDE cover  
The function of the buttons listed in the following table is different when the SLIDE cover is closed and when it is open

SLIDE cover closed	SLIDE cover open
2 ENTER button	ALARM [A] TIME button
3 BAND button	ALARM [B] MODE button
4 SLEEP button	ALARM [B] TIME button
5 ALARM CHECK button	ALARM [B] MODE button
6 RADIO ON button	DATE/CLOCK button
7 RADIO OFF/ALARM RESET button	ALARM CANCEL button

- AC power cord
- FM wire antenna
- Speaker
- Station/day preset buttons
- WAKE UP STATION button (ALARM [A])
- WAKE UP STATION button (ALARM [B])
- Display window
- TUNE/TIME SET buttons (US, CND, E92 model)
- DREAM BAR DATE/SNOOZE (US, CND, E92 model)
- REPEAT ALARM/DATE bar (EXCEPT US, CND, E92 model)
- VOL (volume) control

### Display Section

- Band indication
- ALARM [A] mode indication
- ALARM [B] mode indication
- AM/PM indication (US, CND, AUS, E92 model)
- Days of the week indication
- Time/frequency/date indication
- Preset number indication

- RADIO-BUZZER
- RADIO-BUZZER
- RADIO-BUZZER
- ALARM [A] mode indication
- ALARM [B] mode indication
- AM/PM indication
- Days of the week indication

### Note:

12-hour system (US, CND, AUS, E92 model)	24-hour system (IT, AEC, AEZ, E91 model)
AM 12:00 = midnight PM 12:00 = noon	0:00 = midnight 12:00 = noon



(The illustrations of the time indication in this manual are for models with 12-hour system)

## How to Set the Alarm

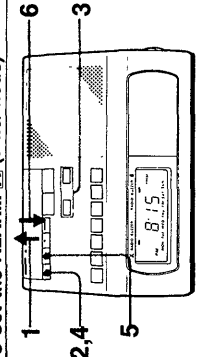
**To Set the ALARM [A] (time/mode)**

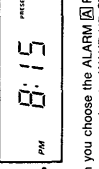

- 1 Open the SLIDE cover.
- 2 Press the ALARM [A] TIME button. The following indication appears in the window.
 
- 3 Set the ALARM [A] TIME with the TUNETIME SET + or - button. The + button advances the hour and minute digits and the - button reverses them. ALARM [A] TIME is set to 7:00 AM at the factory.
- 4 Press the ALARM [A] TIME button again. You hear two beeps and the alarm time has been set.
- 5 Select the mode (buzzer or radio) with the ALARM [A] MODE button. Each time you press the button, the alarm mode changes and the display changes in the following order.
 

Press ALARM [A] MODE	Alarm mode
	Radio
Press ALARM [A] MODE	Buzzer
	No alarm
Press ALARM [A] MODE	
	
- 6 Close the SLIDE cover.

## To Set the ALARM [B] (time/mode)

Follow the steps 2 to 5 described in "To Set the ALARM [A] (time/mode)", using the ALARM [B] TIME and ALARM [B] MODE buttons. The ALARM [B] TIME is set to 7:30 AM at the factory.

When you choose the ALARM [B] RADIO MODE, you will hear the station preset for the WAKE UP STATION [B] button at the preset time.

## When the ALARM is on

The following indication appears in the window.

Example. ALARM A - RADIO MODE, 7:00 AM, Tuesday

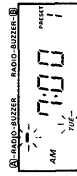

### Notes:

- When ALARM [B] (ALARM [A]) comes on while ALARM [A] (ALARM [B]) is still on, the alarm switches to ALARM [B] (ALARM [A]).
- The buzzer sound level is fixed, and independent of the VOL control.
- The ALARM [A] BUZZER sound and ALARM [B] BUZZER sound are different.
- The interval of the BUZZER ALARM is long at the beginning and gradually becomes shorter.

The radio or buzzer will automatically sound at the preset time, and automatically turn itself off after 59 minutes, unless it is turned off manually.

## To turn off the alarm manually

Press the RADIO OFF/ALARM RESET button. (Make sure that the SLIDE cover is closed.)

## To check the alarm preset time

Press the ALARM CHECK button.

When you press the button once, the ALARM [A] TIME appears in the display window.



When you press the button again, the ALARM [B] TIME appears in the window.

## Snooze Alarm Function

If you awake to the radio or buzzer but want to doze for a few more minutes, just lightly press the DREAM BAR DATE/SNOOZE bar. The radio or buzzer will be silenced but will automatically come on again after about eight minutes. If you want to doze some more, press the bar again.

### Notes:

- If you press the DREAM BAR DATE/SNOOZE bar an hour after the alarm comes on, the alarm will not sound again.
- To cancel the alarm before the alarm time, open the SLIDE cover and press the ALARM [A] MODE and/or ALARM [B] MODE buttons so that the indicators under the ALARM [A] RADIO/BUZZER and the ALARM [B] RADIO/BUZZER indication disappear.

## To Cancel the Day When You Don't Want the Alarm

You can cancel the days when you don't want to be woken by the alarm with the ALARM CANCEL button. Otherwise the alarm turns on at the same time every day.

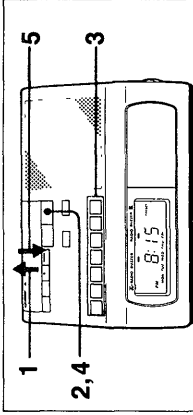

Example: To cancel the alarm for Saturday and Sunday.

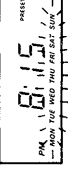
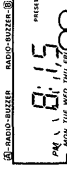
- 1 Open the SLIDE cover.
- 2 Press the ALARM CANCEL button. Days of the week indication starts to flash.
 
- 3 Press the station/day preset button of the day on which you do not want to be awoken. (SAT and SUN) The indication of the day disappears. You can cancel other days of the week by pressing the desired station/day preset buttons.
 
- 4 Press the ALARM CANCEL button again. The alarm will not be turned on on the days whose indication has disappeared.
- 5 Close the SLIDE cover.

To put back the days which you have canceled

- 1 Press the ALARM CANCEL button.
- 2 Press the station/day preset buttons of the days which you have canceled while the indication is flashing. The indication of those days appears again.
- 3 Press the ALARM CANCEL button again.

### Note

Alarm canceling function activates both for ALARM [A] and ALARM [B] and you cannot cancel only ALARM [A] or ALARM [B].

## Radio Operation (Manual Tuning)

- 1 Press the RADIO ON button. The display window shows the band, frequency and the PRESET number of the station before the radio was turned off for five seconds and then shows the time indication.
- 2 Turn the VOL control a little to get sound.
- 3 Select the desired band with the BAND button. AM and FM alternate with each press of the BAND button. (The display window shows the last frequency chosen in each band.)
- 4 Tune in the desired station with the TUNETIME SET + or - button. The AM tuning interval is set to 10 kHz and the FM tuning interval is set to 0.1 MHz.
- 5 Adjust volume.

**Notes**

- The display window shows the band and frequency for five seconds after the radio is turned on and after you have changed the frequency. Then it goes back to the time indication.
- The PRESET number in the display window shows (out) when the radio is tuned to a frequency other than the preset ones by pressing the TUNETIME SET + or - button.

To turn off the radio  
Press the RADIO OFF/ALARM RESET button.

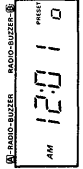

### For improved reception

FM: Extend the FM wire antenna fully to increase the FM sensitivity.  
AM: Since the reception is affected by the position of the radio, rotate the unit horizontally for optimum reception.

## Radio Operation (Preset Tuning)

You can preset up to 7 FM/AM stations (one station for each 1-7 button).

**How to Preset**

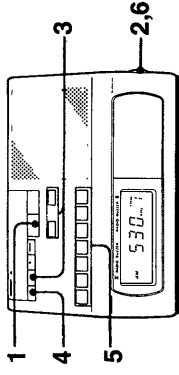

- 1** Press the RADIO ON button.
- 2** Press one of the station/day preset buttons 1-7. The desired station will be received. The band and frequency will be displayed for five seconds and the PRESET number will remain in the display window.
- 3** Press one of the following buttons: RADIO ON button or the station/day preset button of the station you are listening to. The display window shows the band, frequency and the PRESET number of the station before the radio was turned off.
- 4** Press the ENTER button. The PRESET indication "P" flashes.
- 5** Press the desired station/day preset button (2). You hear two beeps. The station being received will be stored for that PRESET number. The display window shows the band and frequency for five seconds and goes back to the time indication. However, the PRESET number stays in the window.
- 6** Adjust volume.

**Note:**  
The station set for button 1 will be the station of ALARM (A).  
RADIO MODE. Preset another station for button 2 for ALARM (A).  
RADIO MODE. (For details on alarm, see "How to Set the Alarm".)

**To change the preset station:**  
Preset a new station for the desired button, following the steps 3 to 5.

## How to Use the Sleep Timer

You can fall asleep to the radio sound knowing that the radio will turn itself off after the preset time period has elapsed.

**To Use Both Sleep Timer and Alarm Function**

- 1** Set the alarm. (See "How to Set the Alarm".)
- 2** Set the sleep timer. (See "How to Use the Sleep Timer".)

You can fall asleep to the radio sound and you will be awoken by the radiobuzzer alarm at the preset time.

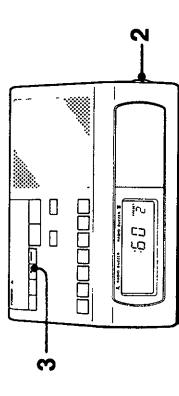

- 1** Tune in the desired station manually or with the station/day preset buttons. (See "Radio Operation".)
- 2** Adjust volume.
- 3** Press the SLEEP button to set the sleep timer operation time. Each time you press the button, the operation time will be reduced. The operation time appears in the display window for a second and then the current time appears.

Sleep timer operation time		Display
Press SLEEP	Operation time	
once	90 minutes	:90
twice	60 minutes	:60
three times	30 minutes	:30
four times	15 minutes	:15
five times	0 (Radio off)	OFF

## SECTION 2 ELECTRICAL ADJUSTMENTS

( ): EXCEPT US, CND, E92 model

### AM Section

AM RF signal generator

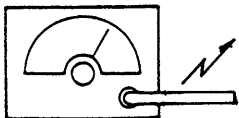

Put the lead-wire antenna close to the set.

30 % amplitude modulation by 400Hz signal  
Output level: as low as possible

### FM Section

FM RF signal generator



FM ANT terminal

±22.5kHz frequency deviation by 400Hz signal  
Output level: as low as possible

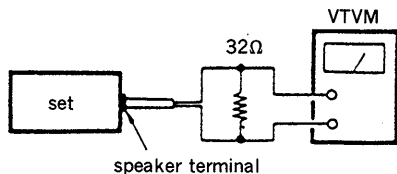

speaker terminal

AM IF ADJUSTMENT	
Adjust for a maximum reading on VTVM.	
L5	450kHz

AM VCO VOLTAGE ADJUSTMENT		
Adjustment Part	Frequency Display	Reading on Digital voltmeter
L4	1,710kHz (1,602kHz)	9V (check)
(confirmation)	530kHz (531kHz)	1.4V

**Note:** Not use the AM RF signal generator in this adjustment.

AM TRACKING ADJUSTMENT	
Adjust for a maximum reading on VTVM.	
CT1	L1
1,490kHz (1,404kHz)	580kHz (621kHz)

FM VCO VOLTAGE ADJUSTMENT		
Adjustment Part	Frequency Display	Reading on Digital voltmeter
L3	108MHz	9V (check)
(confirmation)	87.5MHz	1.4V

**Note:** Not use the FM signal generator in this adjustment.

FM TRACKING ADJUSTMENT	
Adjust for a maximum reading on VTVM.	
CT3	L2
108MHz	87.5MHz

- Repeat the procedures in each adjustment several times, and the tracking adjustments should be finally the trimmer capacitors.

**Adjustment Location :**

**[MAIN BOARD] -COMPONENT SIDE-**

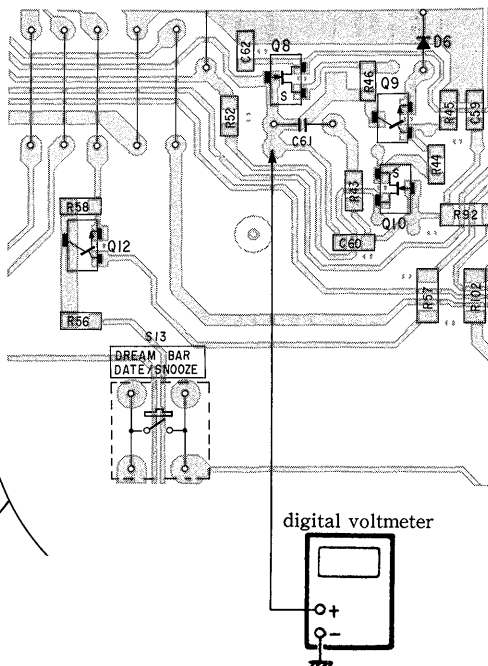
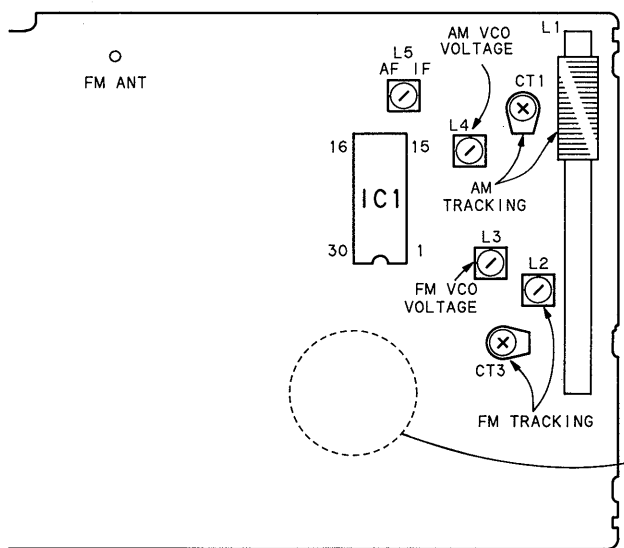

## SECTION 3 PIN DESCRIPTION

### IC2 $\mu$ PD1724GB-551-1A7

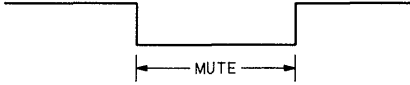
Pin No.	Pin Name	Signal Name	I/O	Description
1-10	LCD10-LCD1	LCD10-LCD1	O	LCD drive
11	NC		—	
12-14	COM3-COM1	COM3-COM1	I	LCD common
15	VSS3		—	Pin for doubler circuit capacitor connection to develop LCD drive voltage
16	CAP2			
17	CAP1			
18	VSS2			
19	VDP	MUTE	O	Audio signal mute. Active : Low. LOW when MUTE ON. 
20	CGP	BEEP	O	Activates buzzer. (1 kHz)
21	NC		—	
22	VDD		—	5V power supply input terminal
23	VHF		I	Unused pin
24	HF	FM VCO	I	FM VCO input
25	AM	LW/MW VCO	I	LW/MW/VC input
26	VSS1		—	GND
27	EO1		O	PLL error output pin
28	EO2			
29	CE	CE	I	Detects power supply line status. Power supply line OFF : Low Power supply line ON : High
30	XO		O	Crystal oscillator connection pin
31	XI		I	
32	VSS4		—	Pin for regulator circuit capacitor connection to attain stable drive voltage of the oscillator
33	PA3	ALARM OUT	O	ALARM OUT
34	PA2	CST IN	I	Cassette control input. (Unused pin)
35	PA1	MODE IN	I	MODE select input A Mode/B Mode select signal input to switch the function of the keys Low : A Mode High : B Mode
36	PA0	CST OUT	O	Cassette control output. (Unused pin)
37	PB3	INIT OUT	O	INITIALIZE OUT Generates INITIALIZE pulse to conduct BAND 12H/24H setting immediately following cold start. ON : High
38	PB2	POWER OUT	O	POWER OUT output Radio power supply control output POWER OFF : Low POWER ON : HIGH (Unused pin)
39	PB1	AM/FM	O	AM/FM select FM : Low AM : High
40	PB0	LW/MW	O	LW/MW select output (Unused pin) LW : High MW : Low

Pin No.	Pin Name	Signal Name	I/O	Description
41-44	PC3-PC0	KEY SOURCE	O	<p>Conducts Key Scan. Timing chart (Eg.) When the PC3 line key is pressed.</p> <p>PC0 PC1 PC2 PC3</p> <p>The pressed key is detected, key scan stop</p> <p>Key is pressed.</p>
45-48	K3-K0	KEY RETURN	I	<p>Key Return input Key Scan</p> <ol style="list-style-type: none"> <li>① Set PC0, PC1, PC2 and PC3 to "High".</li> <li>② When noe of the 15 keys is pressed, PC0-PC3 will be set to "Low".</li> <li>③ Each port is set to "High" (Key scan) in the following order PC0 → PC1 → PC2 → PC3 to determine the pressed key.</li> </ol> <p>K0-K3 input condition The figure in the right indicates that the key following PC1 is pressed.</p> <p>* When the initial key is pressed and held down while the next key is pressed, the second key input will not be accepted until the initial key is released (for +, - keys only). Release the initial key and press the next key so that the second key input will be accepted.</p> <p>PC0 PC1</p> <p>① ② ③</p>
49, 50	NC		—	
51-56	LCD16-LCD11	LCD16-LCD11	O	LCD drive



SECTION 4  
DIAGRAMS

• Semiconductor Location

Ref. No.	Location
D1	C-2
D3	E-2
D4	E-3
D5	G-6
D6	F-6
D8	D-9
D9	H-12
D10	H-10
D11	H-8
D12	C-10
D13	E-10
D14	E-9
D15	E-10
D16	E-10
D17	D-6
D18	A-7
D19	A-7
D21	G-12
D22	G-12
D23	G-13
D24	G-13
IC1	C-5
IC2	C-11
IC3	C-8
IC4	H-3
IC5	G-9
Q5	E-3
Q7	B-6
Q8	F-5
Q9	F-6
Q10	G-6
Q11	F-9
Q12	G-4
Q14	D-8
Q15	D-10

4-1. PRINTED WIRING BOARD • Refer to page 14 for Semiconductor Lead Layouts.

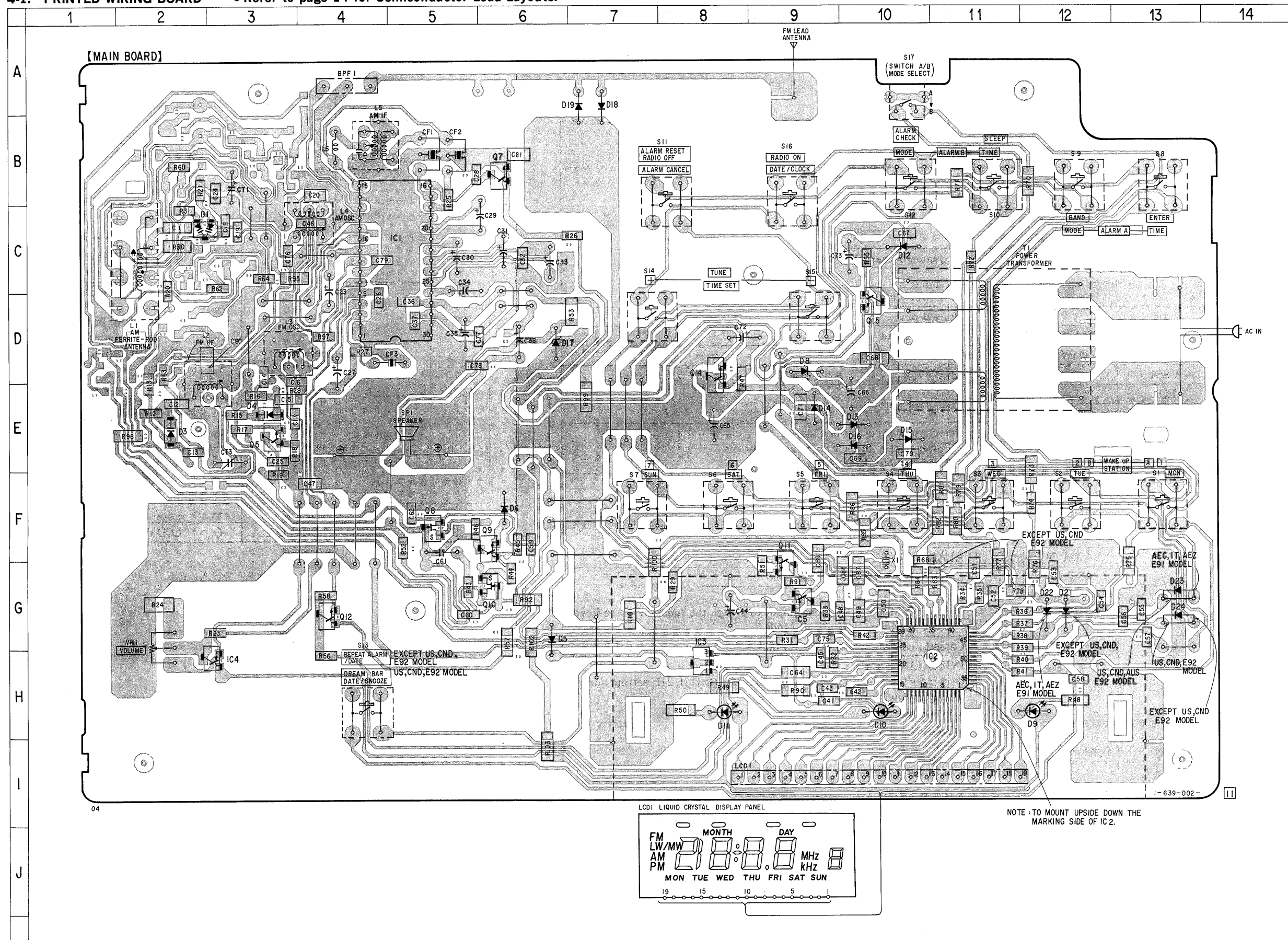

Note:

- : parts extracted from the component side.
- CND: Canadian model
- IT: Italian model
- AUS: Australian model
- AEC: North European model
- E92: Central and South America model

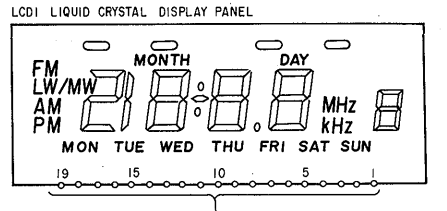

NOTE: TO MOUNT UPSIDE DOWN THE MARKING SIDE OF IC 2.

4-2. SCHEMATIC DIAGRAM

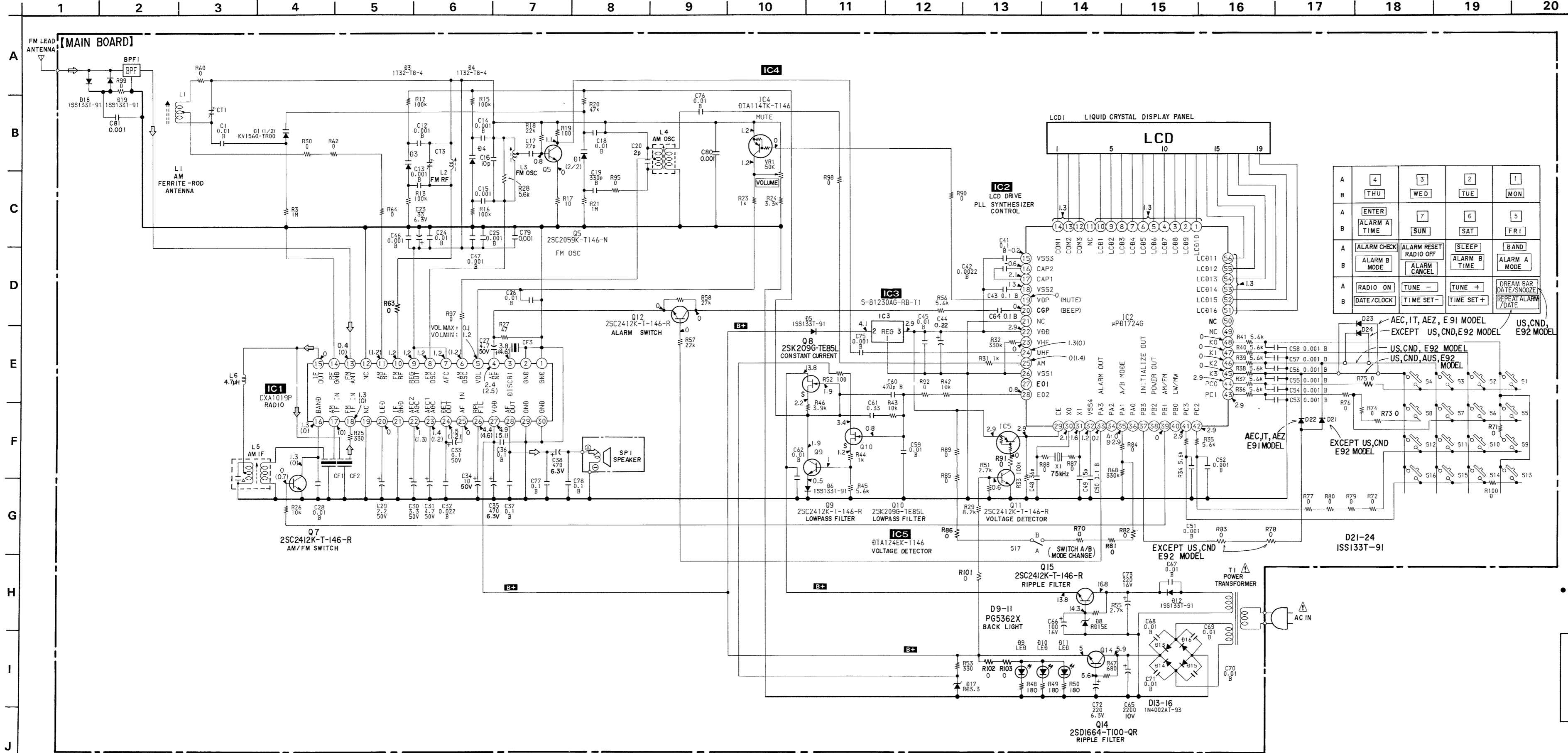

A	4	3	2	1
B	THU	WED	TUE	MON
A	ENTER	7	6	5
B	ALARM A TIME	SUN	SAT	FRI
A	ALARM CHECK	ALARM RESET RADIO OFF	SLEEP	BAND
B	ALARM B MODE	ALARM CANCEL	ALARM B TIME	ALARM A MODE
A	RADIO ON	TUNE -	TUNE +	DREAM BAR DATE/SNOOZE
B	DATE/CLOCK	TIME SET-	TIME SET+	REPEAT ALARM / DATE

**Note:**

- All capacitors are in  $\mu\text{F}$  unless otherwise noted.  $\text{pF}$ :  $\mu\text{F}$  50WV or less are not indicated except for electrolytics and tantalums.
- All resistors are in  $\Omega$  and  $\frac{1}{4}\text{W}$  or less unless otherwise specified.
- $\Delta$ : internal component.

**Note:** The components identified by mark  $\Delta$  or dotted line with mark  $\Delta$  are critical for safety. Replace only with part number specified.

**Note:** Les composants identifiés par une marque  $\Delta$  sont critiques pour la sécurité. Ne les remplacer que par une pièce portant le numéro spécifié.

- Voltage are dc with respect to ground under no-signal (detuned) conditions.
- ( ) : AM
- Voltagés are taken with a VOM (Input Impedance  $10\text{M}\Omega$ ). Voltage variations may be noted due to normal production tolerances.
- Signal path.
- $\Rightarrow$  : FM
- CND: Canadian model
- IT: Italian model
- AUS: Australian model
- AEC: North European model
- E92: Central and South America model

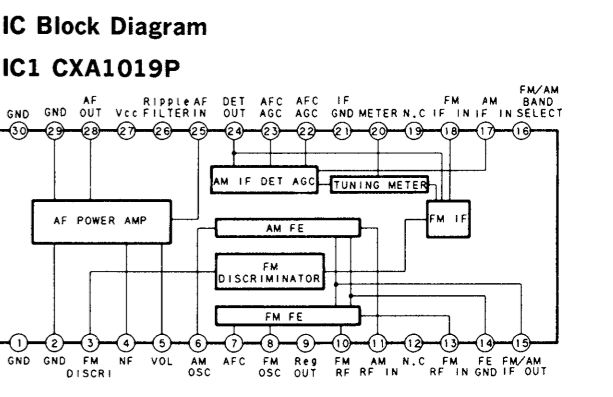

4-3. SEMICONDUCTOR LEAD LAYOUTS

CXA1019S

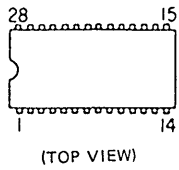

RD15ES-L3  
RD3.3ES-L1

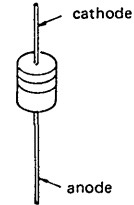

S-81230AG-RB-S

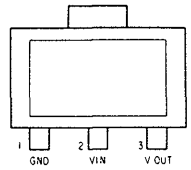

1SS226

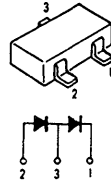

$\mu$ PD1724GB-551-1A7

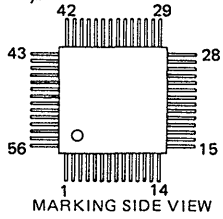

1T32

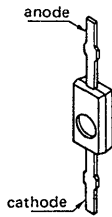

DTA114TK  
DTA124EK  
2SC2059K-N  
2SC2412K-R

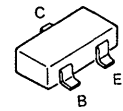

10E2

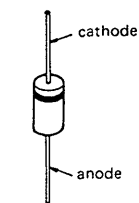

PG5362X

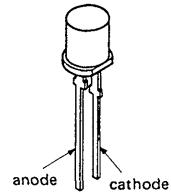

2SD1664-QR

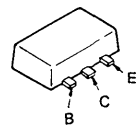

2SK209-G

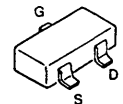

KV1560

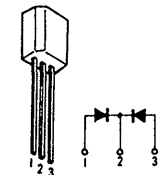

## SECTION 5 EXPLODED VIEWS

**NOTE:**

- The mechanical parts with no reference number in the exploded views are not supplied.
- Items marked "\*" are not stocked since they are seldom required for routine service. Some delay should be anticipated when ordering these items.

- -XX, -X mean standardized parts, so they may have some differences from the original one.

- Color Indication of Appearance Parts  
Example:

KNOB, BALANCE (WHITE)...(RED)  
↑ Parts Color    ↑ Cabinet's Color

- CND: Canadian model
- IT: Italian model
- AUS: Australian model
- AEC: North European model
- E92: Central and South America model

- Hardware(# mark) list is given in the last of this parts list.

The components identified by mark or dotted line with mark are critical for safety. Replace only with part number specified.

Les composants identifiés par une marque sont critiques pour la sécurité. Ne les remplacer que par une pièce portant le numéro spécifié.

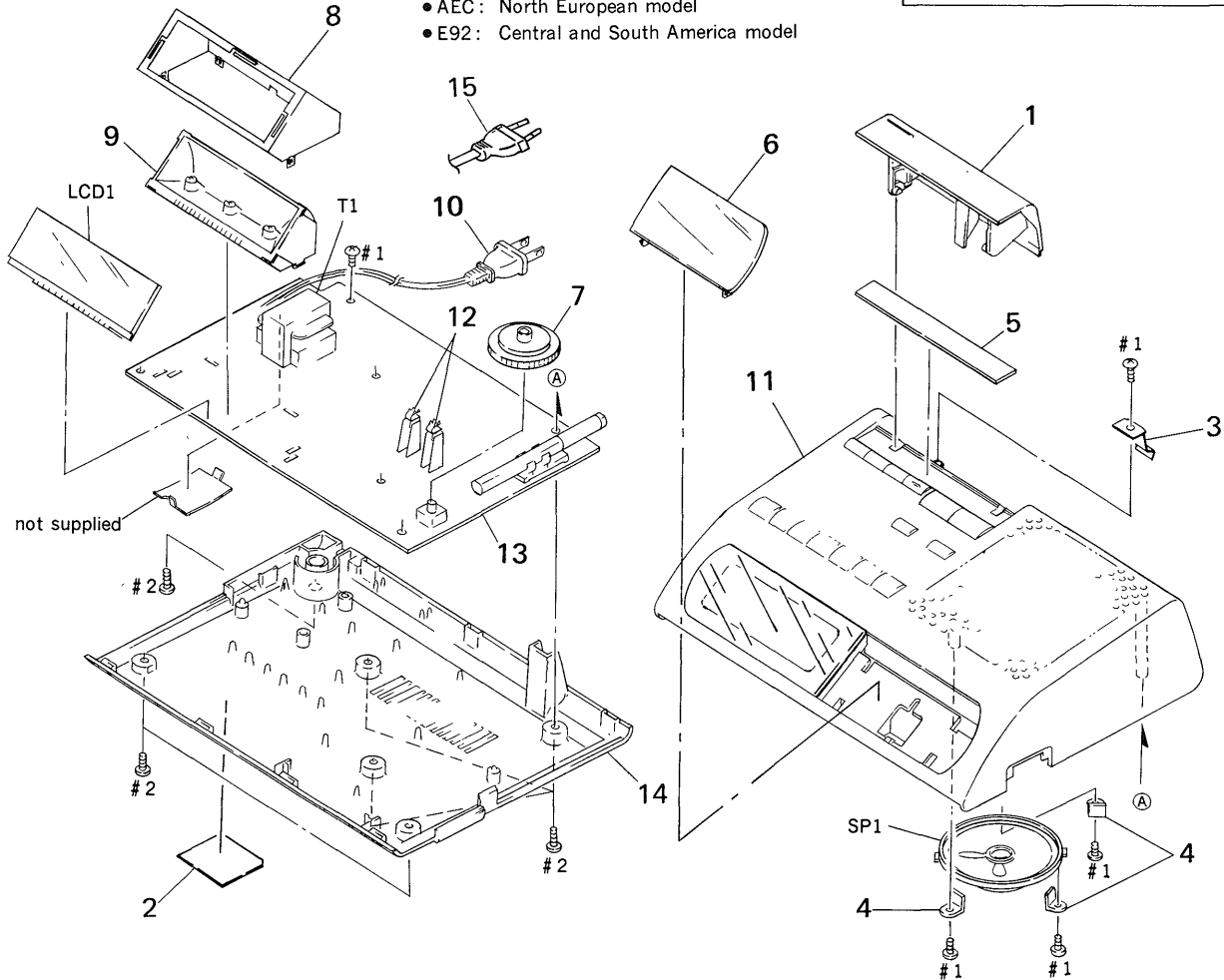

Ref. No.	Part No.	Description	Remark
1	3-367-641-01	PANEL (LID) (EXCEPT IT)	
1	3-367-641-21	PANEL (LID) (IT)	
2	* 3-371-735-01	LABEL, MODEL NUMBER (AUS)	
2	* 3-371-736-01	LABEL, MODEL NUMBER (E92)	
2	* 3-371-737-01	LABEL, MODEL NUMBER (AEZ)	
3	3-368-547-01	SPRING, LEAF	
4	3-593-019-00	CLAW, SPEAKER	
5	3-368-551-01	PLATE, INDICATION	
6	3-367-640-01	BUTTON (SNOOZE) (US, CND, E92)	
6	3-367-640-21	BUTTON (SNOOZE) (EXCEPT US, CND, E92)	
7	3-367-639-01	KNOB (VOLUME) (EXCEPT IT)	
7	3-367-639-11	KNOB (VOLUME) (IT)	
8	* 3-368-553-01	CASE (LCD), SHIELD	
9	3-367-642-01	FRAME, REFLECTION	
10	1-558-566-21	CORD, POWER (US, CND, E92)	

Ref. No.	Part No.	Description	Remark
11	X-3363-446-1	CABINET (UPPER) ASSY	
12	3-368-548-01	TERMINAL, SPEAKER	
13	* A-3661-265-A	MAIN BOARD, COMPLETE (US, CND, E92)	
13	* A-3661-395-A	MAIN BOARD, COMPLETE (EXCEPT US, CND, E92)	
14	3-367-646-01	CABINET (LOWER) (US, CND, E92)	
14	3-367-646-21	CABINET (LOWER) (AEC, E91, AEZ, AUS)	
14	3-367-646-31	CABINET (LOWER) (IT)	
15	1-555-795-00	CORD, POWER (AEC, AEZ, E91)	
15	1-555-815-21	CORD, POWER (AUS)	
LCD1	1-809-403-11	DISPLAY PANEL, LIQUID CRYSTAL	
SP1	1-544-504-11	SPEAKER	
T1	1-450-529-11	TRANSFORMER, POWER (US, E92)	
T1	1-450-635-11	TRANSFORMER, POWER (CND)	
T1	1-450-674-11	TRANSFORMER, POWER (EXCEPT US, CND, E92)	

## SECTION 6 ELECTRICAL PARTS LIST

**MAIN**

**NOTE:**

- Due to standardization, replacements in the parts list may be different from the parts specified in the diagrams or the components used on the set.
- Items marked "\*" are not stocked since they are seldom required for routine service. Some delay should be anticipated when ordering these items.
- -XX, -X mean standardized parts, so they may have some differences from the original one.
- CAPACITORS  
uF:  $\mu$ F

- RESISTORS  
All resistors are in ohms  
METAL: Metal-film resistor  
METAL OXIDE: Metal Oxide-film resistor  
F: nonflammable
- COILS  
uH:  $\mu$ H
- SEMICONDUCTORS  
In each case, u:  $\mu$ , for example:  
uA...:  $\mu$ A..., uPA...:  $\mu$ PA...,  
uPB...:  $\mu$ PB..., uPC...:  $\mu$ PC...,  
uPD...:  $\mu$ PD....
- CND: Canadian model
- IT: Italian model
- AUS: Australian model
- AEC: North European model
- E92: Central and South America model

The components identified by mark  $\Delta$  or dotted line with mark  $\Delta$  are critical for safety. Replace only with part number specified.

Les composants identifiés par une marque  $\Delta$  sont critiques pour la sécurité. Ne les remplacer que par une pièce portant le numéro spécifié.

When indicating parts by reference number, please include the board name.

Ref. No.	Part No.	Description	Remark	Ref. No.	Part No.	Description	Remark
	* A-3661-265-A	MAIN BOARD, COMPLETE (US, CND, E92)		C34	1-124-907-11	ELECT 10uF 20% 50V	
	* A-3661-395-A	MAIN BOARD, COMPLETE (EXCEPT US, CND, E92)		C35	1-124-472-11	ELECT 470uF 20% 10V	
		*****		C36	1-164-004-11	CERAMIC CHIP 0.1uF 10% 25V	
	* 1-535-771-11	TERMINAL (EXCEPT US, CND, E92)		C37	1-164-004-11	CERAMIC CHIP 0.1uF 10% 25V	
	3-367-642-01	FRAME, REFLECTION		C38	1-124-472-11	ELECT 470uF 20% 10V	
	3-368-548-01	TERMINAL, SPEAKER		C41	1-164-004-11	CERAMIC CHIP 0.1uF 10% 25V	
	* 3-368-553-01	CASE (LCD), SHIELD		C42	1-164-161-11	CERAMIC CHIP 0.0022uF 10% 100V	
		< FILTER >		C43	1-164-004-11	CERAMIC CHIP 0.1uF 10% 25V	
BPF1	1-235-171-00	FILTER, BAND PASS		C44	1-125-623-11	CAP, DOUBLE LAYERS 0.22uF	
		< CAPACITOR >		C45	1-164-232-11	CERAMIC CHIP 0.01uF 50V	
C1	1-163-059-00	CERAMIC CHIP 0.01uF 10% 50V		C46	1-163-205-00	CERAMIC CHIP 0.001uF 5% 50V	
C12	1-163-009-11	CERAMIC CHIP 0.001uF 10% 50V		C47	1-163-205-00	CERAMIC CHIP 0.001uF 5% 50V	
C13	1-163-009-11	CERAMIC CHIP 0.001uF 10% 50V		C48	1-163-106-00	CERAMIC CHIP 36PF 5% 50V	
C14	1-163-009-11	CERAMIC CHIP 0.001uF 10% 50V		C49	1-163-161-00	CERAMIC CHIP 15PF 5% 50V	
C15	1-163-205-00	CERAMIC CHIP 0.001uF 5% 50V		C50	1-163-077-00	CERAMIC CHIP 0.1uF 10% 25V	
C16	1-163-093-00	CERAMIC CHIP 10PF 5% 50V		C51	1-163-205-00	CERAMIC CHIP 0.001uF 5% 50V	
C17	1-163-103-00	CERAMIC CHIP 27PF 5% 50V		C52	1-163-009-11	CERAMIC CHIP 0.001uF 10% 50V	
C18	1-164-232-11	CERAMIC CHIP 0.01uF 50V		C53	1-163-009-11	CERAMIC CHIP 0.001uF 10% 50V	
C19	1-163-003-11	CERAMIC CHIP 330PF 10% 50V		C54	1-163-009-11	CERAMIC CHIP 0.001uF 10% 50V	
C20	1-163-085-00	CERAMIC CHIP 2PF 0.25PF 50V		C55	1-163-009-11	CERAMIC CHIP 0.001uF 10% 50V	
C23	1-124-034-51	ELECT 33uF 20% 16V		C56	1-163-009-11	CERAMIC CHIP 0.001uF 10% 50V	
C24	1-164-232-11	CERAMIC CHIP 0.01uF 50V		C57	1-163-009-11	CERAMIC CHIP 0.001uF 10% 50V	
C25	1-163-009-11	CERAMIC CHIP 0.001uF 10% 50V		C58	1-163-009-11	CERAMIC CHIP 0.001uF 10% 50V	
C26	1-164-232-11	CERAMIC CHIP 0.01uF 50V		C59	1-164-232-11	CERAMIC CHIP 0.01uF 50V	
C27	1-124-927-11	ELECT 4.7uF 20% 100V		C60	1-163-005-11	CERAMIC CHIP 470PF 10% 50V	
C28	1-164-232-11	CERAMIC CHIP 0.01uF 50V		C61	1-130-774-00	FILM 0.33uF 10% 63V	
C29	1-124-925-11	ELECT 2.2uF 20% 100V		C62	1-164-232-11	CERAMIC CHIP 0.01uF 50V	
C30	1-123-382-00	ELECT 3.3uF 20% 100V		C64	1-163-077-00	CERAMIC CHIP 0.1uF 10% 25V	
C31	1-124-927-11	ELECT 4.7uF 20% 100V		C65	1-124-893-11	ELECT 2200uF 20% 10V	
C32	1-163-037-11	CERAMIC CHIP 0.022uF 10% 25V		C66	1-126-101-11	ELECT 100uF 20% 16V	
C33	1-124-463-00	ELECT 0.1uF 20% 50V		C67	1-164-232-11	CERAMIC CHIP 0.01uF 50V	
				C68	1-163-059-00	CERAMIC CHIP 0.01uF 10% 50V	
				C69	1-164-232-11	CERAMIC CHIP 0.01uF 50V	
				C70	1-164-232-11	CERAMIC CHIP 0.01uF 50V	

Ref. No.	Part No.	Description	Remark			Ref. No.	Part No.	Description	Remark		
C71	1-163-059-00	CERAMIC CHIP	0.01uF	10%	50V			< COIL >			
C72	1-126-176-11	ELECT	220uF	20%	10V						
C73	1-124-120-11	ELECT	220uF	20%	25V						
C75	1-163-009-11	CERAMIC CHIP	0.001uF	10%	50V						
C76	1-164-232-11	CERAMIC CHIP	0.01uF		50V						
C77	1-164-004-11	CERAMIC CHIP	0.1uF	10%	25V						
C78	1-164-004-11	CERAMIC CHIP	0.1uF	10%	25V						
C79	1-163-009-11	CERAMIC CHIP	0.001MF	10%	50V						
C80	1-163-205-00	CERAMIC CHIP	0.001MF	10%	50V						
C81	1-163-009-11	CERAMIC CHIP	0.001MF	10%	50V						
		< CERAMIC >									
CF1	1-577-319-11	FILTER, CERAMIC						< TRANSISTOR >			
CF2	1-577-324-11	FILTER, CERAMIC									
CF3	1-577-324-11	FILTER, CERAMIC									
		< TRIMMER >									
CT1	* 1-141-227-00	CAP, TRIMMER	20PF								
CT3	1-141-299-11	CAP, CERAMIC TRIMMER									
		< DIODE >									
D1	8-719-951-05	DIODE	KV1560								
D3	8-719-949-46	DIODE	1T32								
D4	8-719-949-46	DIODE	1T32								
D5	8-719-800-76	DIODE	1SS226								
D6	8-719-800-76	DIODE	1SS226								
D8	8-719-121-88	DIODE	RD15ESL3								
D9	8-719-990-84	DIODE	PG5362X								
D10	8-719-990-84	DIODE	PG5362X								
D11	8-719-990-84	DIODE	PG5362X								
D12	8-719-800-76	DIODE	1SS226								
D13	8-719-200-02	DIODE	10E2								
D14	8-719-200-02	DIODE	10E2								
D15	8-719-200-02	DIODE	10E2								
D16	8-719-200-02	DIODE	10E2								
D17	8-719-119-78	DIODE	RD3.3ESL1								
D18	8-719-800-76	DIODE	1SS226								
D19	8-719-800-76	DIODE	1SS226								
D21	8-719-800-76	DIODE	1SS226 (EXCEPT US, CND, E92)								
D22	8-719-800-76	DIODE	1SS226 (AEC, IT, AEZ, E91)								
D23	8-719-800-76	DIODE	1SS226 (EXCEPT, US, CND, E92)								
D24	8-719-800-76	DIODE	1SS226 (AEC, IT, AEZ, E91)								
		< IC >									
IC1	8-752-035-29	IC	CXA1019S								
IC2	8-759-154-63	IC	UPD1724GB-551-1A7								
IC3	8-759-939-41	IC	S-81230AG-RB-S								
IC4	8-729-900-51	TRANSISTOR	DTA114TK								
IC5	8-729-901-05	TRANSISTOR	DTA124EK								
L1	1-402-556-11	ANTENNA, FERRITE-ROD									
L2	1-426-558-11	COIL (RF)									
L3	1-426-557-11	COIL (RF)									
L4	1-426-556-11	COIL (RF)									
L5	1-404-790-11	TRANSFORMER, 1F									
L6	1-410-969-11	INDUCTOR	4.7uH								
		< LCD >									
LCD1	1-809-403-11	DISPLAY PANEL, LIQUID CRYSTAL									
		< TRANSISTOR >									
Q5	8-729-920-38	TRANSISTOR	2SC2059K-N								
Q7	8-729-901-78	TRANSISTOR	2SC2412K-R								
Q8	8-729-220-93	TRANSISTOR	2SK209-G								
Q9	8-729-901-78	TRANSISTOR	2SC2412K-R								
Q10	8-729-220-93	TRANSISTOR	2SK209-G								
Q11	8-729-901-78	TRANSISTOR	2SC2412K-R								
Q12	8-729-901-78	TRANSISTOR	2SC2412K-R								
Q14	8-729-920-85	TRANSISTOR	2SD1664-QR								
Q15	8-729-901-78	TRANSISTOR	2SC2412K-R								
		< RESISTOR >									
R3	1-216-121-00	METAL CHIP	1M	5%	1/10W						
R12	1-216-097-00	METAL CHIP	100K	5%	1/10W						
R13	1-216-097-00	METAL CHIP	100K	5%	1/10W						
R15	1-216-097-00	METAL CHIP	100K	5%	1/10W						
R16	1-216-097-00	METAL CHIP	100K	5%	1/10W						
R17	1-216-001-00	METAL CHIP	10	5%	1/10W						
R18	1-216-081-00	METAL CHIP	22K	5%	1/10W						
R19	1-216-025-00	METAL CHIP	100	5%	1/10W						
R20	1-216-089-00	METAL CHIP	47K	5%	1/10W						
R21	1-216-121-00	METAL CHIP	1M	5%	1/10W						
R22	1-216-097-00	METAL CHIP	100K	5%	1/10W						
R23	1-216-049-00	METAL CHIP	1K	5%	1/10W						
R24	1-216-061-00	METAL CHIP	3.3K	5%	1/10W						
R25	1-216-037-00	METAL CHIP	330	5%	1/10W						
R26	1-216-073-00	METAL CHIP	10K	5%	1/10W						
R27	1-216-017-00	METAL CHIP	47	5%	1/10W						
R28	1-216-067-00	METAL CHIP	5.6K	5%	1/10W						
R29	1-216-071-00	METAL CHIP	8.2K	5%	1/10W						
R30	1-216-296-00	METAL CHIP	0	5%	1/8W						
R31	1-216-049-00	METAL CHIP	1K	5%	1/10W						
R32	1-216-109-00	METAL CHIP	330K	5%	1/10W						
R33	1-216-097-00	METAL CHIP	100K	5%	1/10W						
R34	1-216-067-00	METAL CHIP	5.6K	5%	1/10W						
R35	1-216-067-00	METAL CHIP	5.6K	5%	1/10W						
R36	1-216-067-00	METAL CHIP	5.6K	5%	1/10W						

MAIN

Ref. No.	Part No.	Description	Remark
R37	1-216-067-00	METAL CHIP 5.6K	5% 1/10W
R38	1-216-067-00	METAL CHIP 5.6K	5% 1/10W
R39	1-216-067-00	METAL CHIP 5.6K	5% 1/10W
R40	1-216-067-00	METAL CHIP 5.6K	5% 1/10W
R41	1-216-067-00	METAL CHIP 5.6K	5% 1/10W
R42	1-216-073-00	METAL CHIP 10K	5% 1/10W
R43	1-216-073-00	METAL CHIP 10K	5% 1/10W
R44	1-216-049-00	METAL CHIP 1K	5% 1/10W
R45	1-216-067-00	METAL CHIP 5.6K	5% 1/10W
R46	1-216-063-00	METAL CHIP 3.9K	5% 1/10W
R47	1-216-045-00	METAL CHIP 680	5% 1/10W
R48	1-216-180-00	METAL GLAZE 180	5% 1/8W
R49	1-216-180-00	METAL GLAZE 180	5% 1/8W
R50	1-216-180-00	METAL GLAZE 180	5% 1/8W
R51	1-216-059-00	METAL CHIP 2.7K	5% 1/10W
R52	1-216-025-00	METAL CHIP 100	5% 1/10W
R53	1-216-186-00	METAL GLAZE 330	5% 1/8W
R55	1-216-059-00	METAL CHIP 2.7K	5% 1/10W
R56	1-216-067-00	METAL CHIP 5.6K	5% 1/10W
R57	1-216-230-00	METAL GLAZE 22K	5% 1/8W
R58	1-216-083-00	METAL CHIP 27K	5% 1/10W
R60	1-216-295-00	METAL CHIP 0	5% 1/10W
R62	1-216-295-00	METAL CHIP 0	5% 1/10W
R63	1-216-295-00	METAL CHIP 0	5% 1/10W
R64	1-216-295-00	METAL CHIP 0	5% 1/10W
R68	1-216-109-00	METAL CHIP 330K	5% 1/10W
R70	1-216-296-00	METAL CHIP 0	5% 1/8W
R71	1-216-296-00	METAL CHIP 0	5% 1/8W
R72	1-216-295-00	METAL CHIP 0	5% 1/10W
R73	1-216-296-00	METAL CHIP 0	5% 1/8W
R74	1-216-295-00	METAL CHIP 0	5% 1/10W
R75	1-216-296-00	METAL CHIP 0	5% 1/8W
R76	1-216-296-00	METAL CHIP 0	5% 1/8W
R77	1-216-296-00	METAL CHIP 0	5% 1/8W
R78	1-216-296-00	METAL CHIP 0	5% 1/8W
		(EXCEPT US, CND, E92)	
R79	1-216-296-00	METAL CHIP 0	5% 1/8W
R80	1-216-296-00	METAL CHIP 0	5% 1/8W
R81	1-216-296-00	METAL CHIP 0	5% 1/8W
R82	1-216-296-00	METAL CHIP 0	5% 1/8W
R83	1-216-296-00	METAL CHIP 0	5% 1/8W
		(EXCEPT US, CND, E92)	
R84	1-216-296-00	METAL CHIP 0	5% 1/8W
R85	1-216-296-00	METAL CHIP 0	5% 1/8W
R86	1-216-296-00	METAL CHIP 0	5% 1/8W
R87	1-216-296-00	METAL CHIP 0	5% 1/8W
R88	1-216-296-00	METAL CHIP 0	5% 1/8W
R89	1-216-296-00	METAL CHIP 0	5% 1/8W
R90	1-216-296-00	METAL CHIP 0	5% 1/8W

Ref. No.	Part No.	Description	Remark
R91	1-216-295-00	METAL CHIP 0	5% 1/10W
R92	1-216-296-00	METAL CHIP 0	5% 1/8W
R95	1-216-296-00	METAL CHIP 0	5% 1/8W
R97	1-216-295-00	METAL CHIP 0	5% 1/10W
R98	1-216-296-00	METAL CHIP 0	5% 1/8W
R99	1-216-296-00	METAL CHIP 0	5% 1/8W
R100	1-216-296-00	METAL CHIP 0	5% 1/8W
R101	1-216-296-00	METAL CHIP 0	5% 1/8W
R102	1-216-296-00	METAL CHIP 0	5% 1/8W
R103	1-216-296-00	METAL CHIP 0	5% 1/8W
		< SWITCH >	
S1	1-554-303-11	SWITCH, KEY BOARD (1, MON)	
S2	1-554-303-11	SWITCH, KEY BOARD (2, TUE)	
S3	1-554-303-11	SWITCH, KEY BOARD (3, WED)	
S4	1-554-303-11	SWITCH, KEY BOARD (4, THU)	
S5	1-554-303-11	SWITCH, KEY BOARD (5, FRI)	
S6	1-554-303-11	SWITCH, KEY BOARD (6, SAT)	
S7	1-554-303-11	SWITCH, KEY BOARD (7, SUN)	
S8	1-554-303-11	SWITCH, KEY BOARD (ENTER, ALARM A TIME)	
S9	1-554-303-11	SWITCH, KEY BOARD (BAND, ALARM A MODE)	
S10	1-554-303-11	SWITCH, KEY BOARD (SLEEP, ALARM B TIME)	
S11	1-554-303-11	SWITCH, KEY BOARD (ALARM RESET RADIO OFF, ALARM CANCEL)	
S12	1-554-303-11	SWITCH, KEY BOARD (ALARM CHECK, ALARM B MODE)	
S13	1-554-303-11	SWITCH, KEY BOARD (DREAM BAR DATE/SNOOZE)	
S14	1-554-303-11	SWITCH, KEY BOARD (TUNE+, TIME SET+)	
S15	1-554-303-11	SWITCH, KEY BOARD (TUNE-, TIME SET-)	
S16	1-554-303-11	SWITCH, KEY BOARD (RADIO ON, DATE/CLOCK)	
S17	1-571-958-11	SWITCH, PUSH (1 KEY) (SWITCH A/B MODE CHANGE)	
		< TRANSFORMER >	
T1	△. 1-450-529-11	TRANSFORMER, POWER (US, E92)	
T1	△. 1-450-635-11	TRANSFORMER, POWER (CND)	
T1	△. 1-450-674-11	TRANSFORMER, POWER (EXCEPT US, CND, E92)	
		< VARIABLE. RES >	
VR1	1-241-532-11	RES, VAR (VOLUME)	
		< CRYSTAL >	
X1	1-567-769-11	VIBRATOR, CRYSTAL (75kHz)	

\*\*\*\*\*

**Note:**  
The components identified by mark  $\Delta$  or dotted line with mark  $\Delta$  are critical for safety. Replace only with part number specified.

**Note:**  
Les composants identifiés par une marque  $\Delta$  sont critiques pour la sécurité. Ne les remplacer que par une pièce portant le numéro spécifié.

Ref. No.	Part No.	Description	Remark
		MISCELLANEOUS *****	
10	△ . 1-558-566-21	CORD, POWER (US, CND, E92)	
15	△ . 1-555-795-00	CORD, POWER (AEC, AEZ, E91)	
15	△ . 1-555-815-21	CORD, POWER (AUS)	
SP1	1-544-504-11	SPEAKER	

\*\*\*\*\*

ACCESSORY & PACKING MATERIAL  
\*\*\*\*\*

- \* 3-369-339-01 INDIVIDUAL CARTON (US, E92)
- \* 3-369-339-11 INDIVIDUAL CARTON (EXCEPT US, E92)
- \* 3-704-282-01 BAG (STANDARD), PROTECTION
- 3-753-307-11 MANUAL, INSTRUCTION (EXCEPT US, E92)  
(ENGLISH, FRENCH, GERMAN, SPANISH, PORTUGUESE)
- 3-753-307-21 MANUAL, INSTRUCTION (US, E92) (ENGLISH)
- 3-753-307-41 MANUAL, INSTRUCTION (AEC)  
(ITALIAN, SWEDISH, DUTCH)
- 3-753-307-51 MANUAL, INSTRUCTION (CND)  
(ENGLISH, FRENCH, GERMAN, ITALIAN, DUTCH)

\*\*\*\*\*

HARDWARE LIST

#1	7-685-546-14	SCREW +BTP	3X8	TYPE2	N-S
#2	7-685-648-79	SCREW +BTP	3X12	TYPE2	N-S

<p><b>Note:</b> The components identified by mark △ or dotted line with mark △ are critical for safety. Replace only with part number specified.</p>	<p><b>Note:</b> Les composants identifiés par une marque △ sont critiques pour la sécurité. Ne les remplacer que par une pièce portant le numéro spécifié.</p>
--	--



