

ICF-C703

SERVICE MANUAL

US Model
Canadian Model
AEP Model

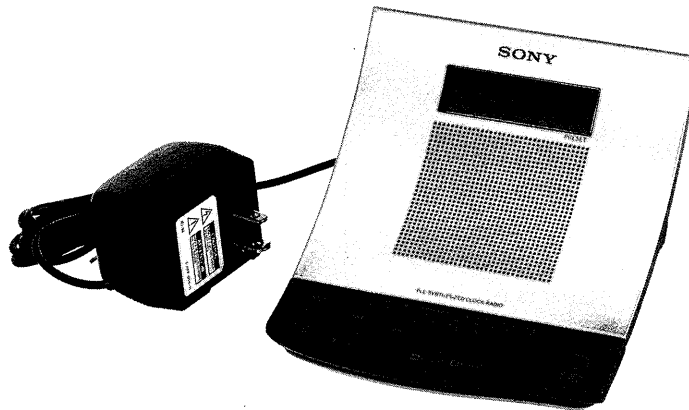

Photo : US, Canadian model

SPECIFICATIONS

Time display:

US, CND model: 12-hour system

AEP, G, IT, ES model: 24-hour system

Frequency range:

	Band	Frequency range	Channel step
US, CND model	FM	87.5 - 108 MHz	0.1 MHz (fixed)
	AM	530 - 1,710 kHz	10 kHz (fixed)
AEP, G, IT, ES model	FM	87.5 - 108 MHz	0.05*MHz (fixed)
	AM	531 - 1,602 kHz	9 kHz (fixed)

*The frequency display is raised or lowered by a step of 0.1 MHz. (Example: Frequency 88.05 MHz is displayed as "88.0 MHz".)

Intermediate frequency:

FM: 10.7 MHz, AM: 450 kHz

Speaker: Approx. 5.7 cm (2 1/4 inches) dia.

Power output: 150 mW (at 10 % harmonic distortion)

Power requirements:

US, CND model: 120V AC, 60Hz

AEP, G, IT, ES model: 220—230V AC, 50Hz

Dimensions: Approx. 128 × 92.8 × 137 mm (w/h/d)
(5 1/8 × 3 3/4 × 5 1/2 inches) incl. projecting parts and controls

Mass: Approx. 495 g (1 lb 2 oz)

Accessory supplied: FM antenna coupler
(1, AEP model only)

Design and specifications subject to change without notice.

Note

This appliance conforms with EEC Directive 87/308/EEC regarding interference suppression.

Features

- Dual alarm PLL (phase locked loop) synthesized clock radio
- Display with adjustable brightness
- 5 random memory presets
- Self power back-up:
Even if the power supply is interrupted, the time setting and the memory will be backed up for 1 hour without battery.

• Abbreviations

CND : Canadian model

G : German model

IT : Italian model

ES : Spanish model

FM/AM PLL SYNTHESIZED CLOCK RADIO
SONY®

SAFETY CHECK-OUT (US Model)

After correcting the original service problem, perform the following safety check before releasing the set to the customer:

Check the antenna terminals, metal trim, "metallized" knobs, screws, and all other exposed metal parts for AC leakage. Check leakage as described below.

LEAKAGE TEST

The AC leakage from any exposed metal part to earth ground and from all exposed metal parts to any exposed metal part having a return to chassis, must not exceed 0.5 mA (500 microampers). Leakage current can be measured by any one of three methods.

1. A commercial leakage tester, such as the Simpson 229 or RCA WT-540A. Follow the manufacturers' instructions to use these instruments.
2. A battery-operated AC milliammeter. The Data Precision 245 digital multimeter is suitable for this job.
3. Measuring the voltage drop across a resistor by means of a VOM or battery-operated AC voltmeter. The "limit" indication is 0.75 V, so analog meters must have an accurate low-voltage scale. The Simpson 250 and Sanwa SH-63Trd are examples of a passive VOM that is suitable. Nearly all battery operated digital multimeters that have a 2V AC range are suitable. (See Fig. A)

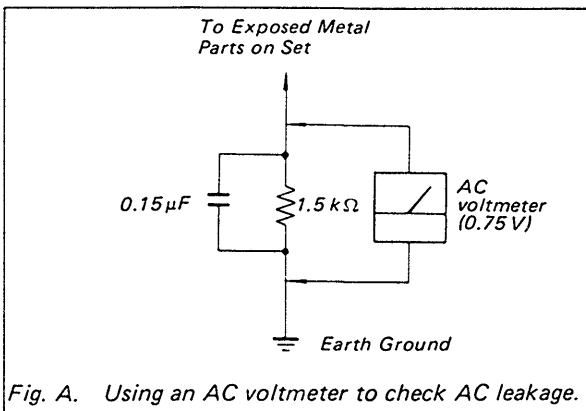

SAFETY-RELATED COMPONENT WARNING!!

COMPONENTS IDENTIFIED BY MARK \triangle OR DOTTED LINE WITH MARK \triangle ON THE SCHEMATIC DIAGRAMS AND IN THE PARTS LIST ARE CRITICAL TO SAFE OPERATION. REPLACE THESE COMPONENTS WITH SONY PARTS WHOSE PART NUMBERS APPEAR AS SHOWN IN THIS MANUAL OR IN SUPPLEMENTS PUBLISHED BY SONY.

MODEL IDENTIFICATION

—Model Number label—

Carved on cabinet (lower)

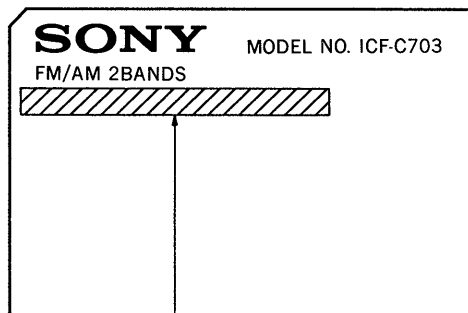

US, Canadian model: AC: 120V~60Hz 3W

Model number label on POWER unit: AEP, German, Italian, Spanish model

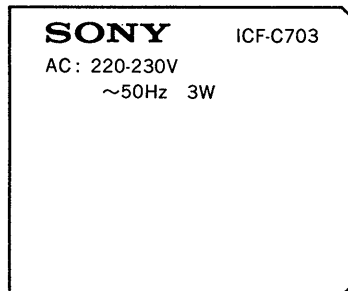

ATTENTION AU COMPOSANT AYANT RAPPORT À LA SÉCURITÉ!

LES COMPOSANTS IDENTIFIÉS PAR UNE MARQUE \triangle SUR LES DIAGRAMMES SCHÉMATIQUES ET LA LISTE DES PIÈCES SONT CRITIQUES POUR LA SÉCURITÉ DE FONCTIONNEMENT. NE REMPLACER CES COMPOSANTS QUE PAR DES PIÈCES SONY DONT LES NUMÉROS SONT DONNÉS DANS CE MANUEL OU DANS LES SUPPLÉMENTS PUBLIÉS PAR SONY.

SECTION 1 GENERAL

This section is extracted from instruction manual.

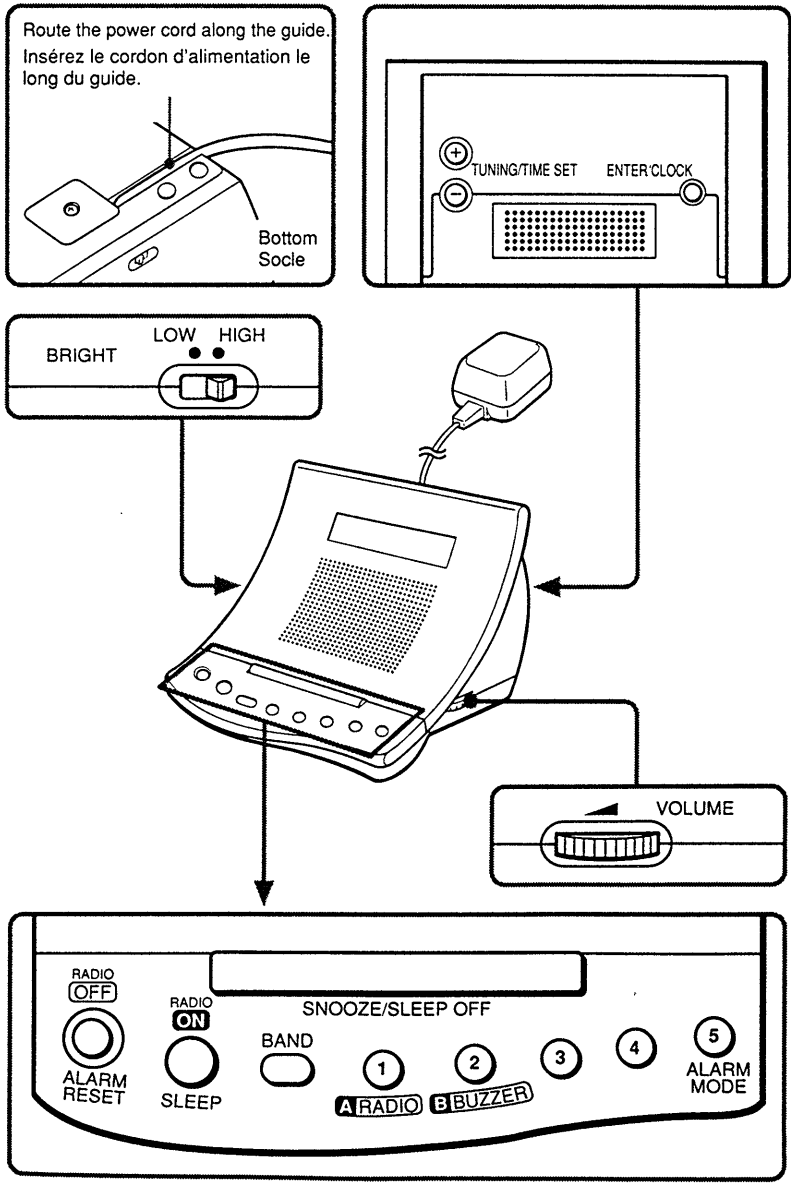

Setting the Clock

1. Plug in the unit.
The display will flash "AM 12:00" or "0:00".
2. While holding down ENTER/CLOCK, press either + or - of TUNING/TIME SET till the correct time appears in the display. When you release ENTER/CLOCK, the clock begins to operate and ":" flashes.

- The clock system varies depending on the model you own.
12-hour system: "AM 12:00" = midnight
24-hour system: "0:00" = midnight
- To set the current time rapidly, keep pressing ENTER/CLOCK and the + or - button together to advance or return to a time that is within a few minutes of the current time. Then press the + or - button to set the time to the current time.

Changing the Brightness of the Display Window

To change the brightness of the display window, slide BRIGHT (brightness).

Operating the Radio

Manual Tuning

1. Press RADIO ON/SLEEP to turn on the radio.
The band, frequency and preset number indications will be displayed in the display window after "On" and preset number appear for about 2 seconds. They change to the current time indication after about 10 seconds.
2. Adjust VOLUME.
3. Press BAND to select the band.
Every push changes the band as follows. (The last frequency selected in each band appears.)

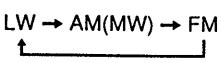

FM/AM = ICF-C703 only
FM/MW/LW = ICF-C703L only

4. Tune in a station by pressing the + or - button of TUNING/TIME SET.
The FM channel step is set to 0.1 MHz (North and South American model) or 0.05 MHz (other models; The FM frequency indication changes every 0.1 MHz.).
The AM(MW) channel step is set to 10 kHz for models for North and South America and 9 kHz for models for other countries.
The LW channel step alternates between 2 kHz and 7 kHz.
A beep sounds at the band edge.
- To turn off the radio, press RADIO OFF/ALARM RESET.
 - To improve radio reception
FM: Since the antenna is encased in the AC power cord, extend the cord to improve FM reception.
AM(MW)/LW: Rotate the unit horizontally for optimum reception. A ferrite bar antenna is built into the unit.
 - To check the station you are listening to, press RADIO ON/SLEEP.
The band and frequency appear for 10 seconds.

For the Customers Supplied with an FM Antenna Coupler

Clamp the AC power cord with the supplied coupler and connect it to a wall FM antenna terminal for optimum FM reception.

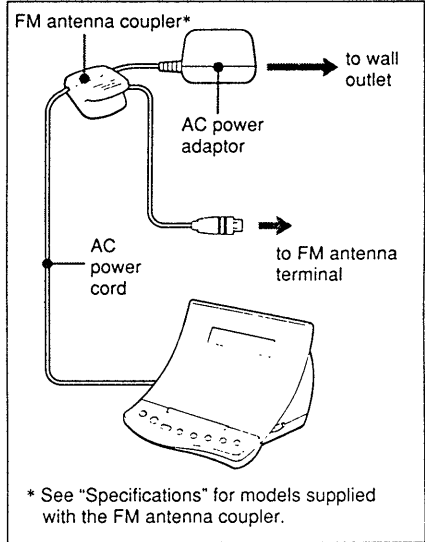

* See "Specifications" for models supplied with the FM antenna coupler.

Preset Tuning

Presetting the Station

You can preset up to 5 stations in FM/AM(MW)/LW with numbered buttons 1 to 5.

Example: To set AM 1260 kHz in preset number 2.

1. Tune in to AM 1260 kHz (See "Manual Tuning").
2. Press **ENTER/CLOCK**.
"P" flashes for about 10 seconds.

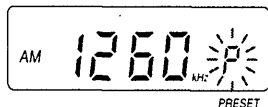

3. Press the "2" button while "P" is flashing.
The beep sounds twice and the station is preset. Though the indication changes to the current time after 10 seconds, the preset number remains.



- To change the preset station, set a new station's frequency in the number whose station you want to change. The previous frequency is canceled.
- Note that the preset 1 station is used for the wake up station of the radio alarm.

Tuning in a Preset Station

1. Press **RADIO ON/SLEEP** to turn on the radio.
 2. Press the preset number button of the station.
The band, frequency and preset number appear in the display window. After 10 seconds, the indication changes to the current time. The preset number remains.
- To turn off the radio, press **RADIO OFF/ALARM RESET**.
 - To check the station you are listening to, press the preset number button. The band and frequency appear for 10 seconds.

Setting the Alarm

You can set the radio and buzzer alarms. The wake up station is that preset in number 1. To set the radio alarm, first preset a desired station for wake up to the preset number 1 (see "Preset Tuning"), and adjust the volume.

1. Turn off the radio.
2. While holding down **A RADIO** or **B BUZZER**, press either + or - of **TUNING/TIME SET** till the desired time appears in the display.
The **A RADIO** or **B BUZZER** indicator flashes while these buttons are being held down.

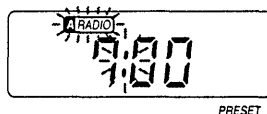

3. Release **A RADIO** or **B BUZZER**.
The alarm time is set. The indication becomes the current time.
4. Press **ALARM MODE** till the alarm you want to set appears in the display.
Each push changes the alarm indication as follows.

No alarm → A RADIO → B BUZZER
↑ A RADIO / B BUZZER ←

When you want to set both **A RADIO** and **B BUZZER** alarm, set both **A RADIO** and **B BUZZER** alarm time by performing steps 2 and 3 above.
The radio or buzzer will automatically sound at the preset time, and automatically turn itself off after 60 minutes, unless it is turned off manually.

- To shut off the alarm manually, press **RADIO OFF/ALARM RESET**. The alarm will come on at the preset time the next day.
- To cancel the alarm before the alarm time, press **ALARM MODE** till the appropriate alarm indication disappears.
- To check the preset time, press **A RADIO** or **B BUZZER**.

Notes

- The buzzer sound level is fixed, and independent of the **VOLUME** dial.
- If you set **A RADIO** and **B BUZZER** to the same desired time, only **A RADIO** will work.

To Doze for a Few More Minutes

1. Press **SNOOZE/SLEEP OFF**.
The radio or buzzer will shut off but will automatically come on again after about 8 minutes.
You can repeat this process within 1 hour.
- When the snooze alarm function is operating, the alarm indication flashes.

Setting the Sleep Timer

Enjoy falling asleep to the radio using the built-in sleep timer that shuts off the radio automatically at a preset time.

1. Press **RADIO ON/SLEEP** repeatedly.
The radio turns on. You can set the sleep timer of 90, 60, 30 or 15 minutes.
Each push changes the display as follows.

Current time → On → 90
↑ ↓
15 ← 30 ← 60

The radio will play for the time you set, then shut off.

- To turn off the radio before the preset time, press **SNOOZE/SLEEP OFF**.

To Use Both Sleep Timer and Alarm Function

You can fall asleep to the radio sound and be awakened by the radio/buzzer alarm at the preset time.

1. Set the alarm. (See "Setting the Alarm")
2. Set the sleep timer. (See "Setting the Sleep Timer")

Note

When the alarm time arrives while the sleep timer is working, the sleep timer is canceled and the alarm sounds.

SECTION 2 ELECTRICAL ADJUSTMENTS

● AM Section

Setting :

BAND switch : AM

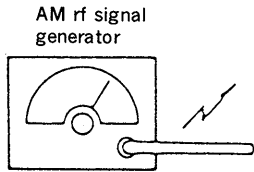

Put the lead-wire antenna close to the set.

30% amplitude modulation by 400Hz signal
output level: as low as possible

● FM Section

Setting :

BAND switch : FM

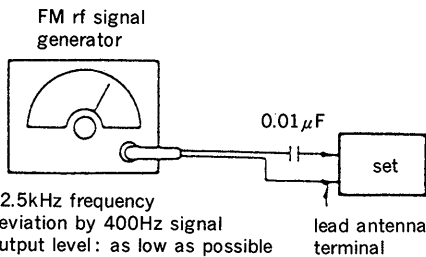

22.5kHz frequency deviation by 400Hz signal
output level: as low as possible

VTVM
(range: 0.5—5V ac)

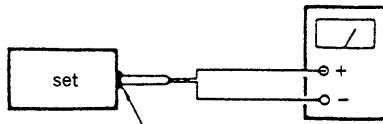

speaker terminal

- Repeat the procedures in each adjustment several times, and the frequency coverage and tracking adjustments should be finally done by the trimmer capacitors.

AM IF ADJUSTMENT		
Adjust for a maximum reading on VTVM.		
T1		
450kHz		

AM VCO VOLTAGE ADJUSTMENT		
Adjustment Part	Frequency Display	Reading on Digital voltmeter
L4	530kHz (531kHz)	1.2±0.1V
confirmation	1,710kHz (1,602kHz)	check 7.6±1.0V (7.0±1.0V)

Note : Not use the AM RF signal generator in this adjustment.

() : AEP, German, Italian, Spanish model

AM TRACKING ADJUSTMENT		
Adjust for a maximum reading on VTVM.		
L1 CT1		
580kHz (621kHz)	1,490kHz (1,404kHz)	

() : AEP, German, Italian, Spanish model

FM VCO VOLTAGE ADJUSTMENT		
Adjustment Part	Frequency Display	Reading on Digital voltmeter
L3	87.5MHz	2.0±0.1V
confirmation	108MHz	check 9.8±1.0V

Note : Not use the FM RF signal generator in this adjustment.

FM TRACKING ADJUSTMENT	
Adjust for a maximum reading on VTVM.	
L2	CT3
87.5MHz	108MHz

Adjustment Location : radio board (component side)

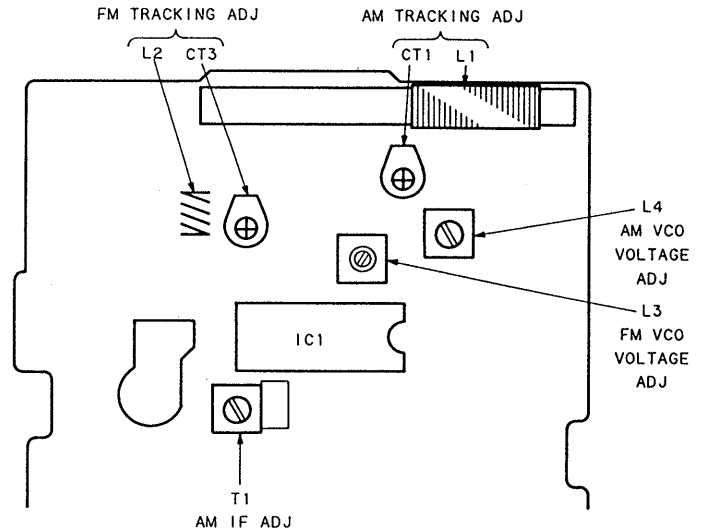

Adjustment Location : radio board (conductor side)

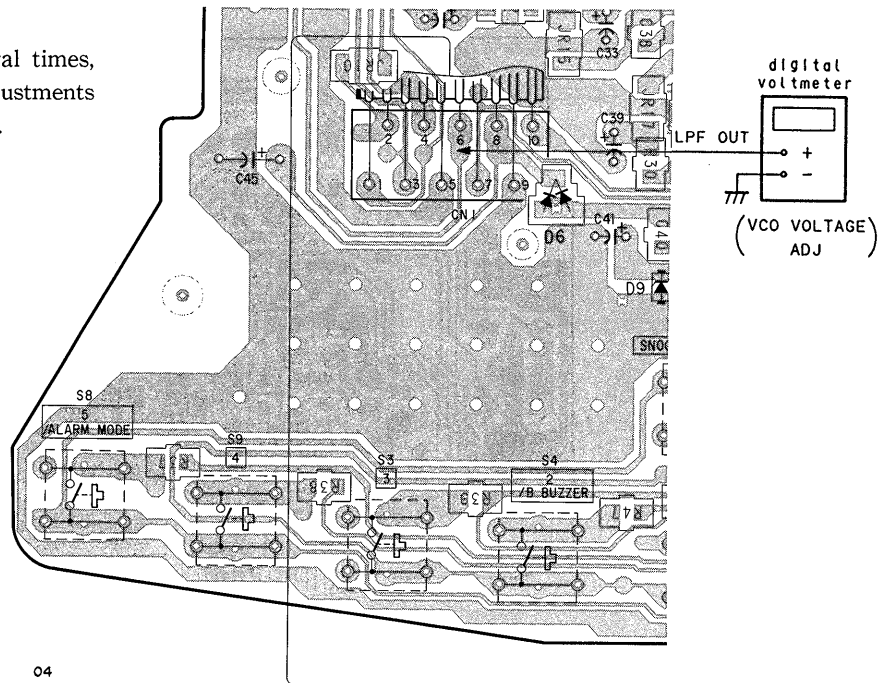

04

SECTION 3 PIN DESCRIPTION

IC101 μ PD1724GB-589-1A7

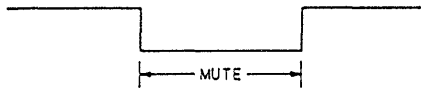
Pin No.	Pin Name	Signal Name	I/O	Description
1-10	LCD10-LCD1	LCD10-LCD1	O	LCD drive segment signal
11	NC		—	Connected to GND.
12-14	COM3-COM1	COM3-COM1	O	LCD drive common signal
15	VSS3		—	Pin for doubler circuit capacitor connection to develop LCD drive voltage
16	CAP2			
17	CAP1			
18	VSS2			
19	VDP	$\overline{\text{MUTE}}$	O	Audio signal mute. Active : Low. LOW when MUTE ON. 
20	CGP	BEEP	O	Activates buzzer. (1 kHz)
21	NC		—	Connected to +3V.
22	VDD		—	3V power supply input terminal
23	VCOH	TV VCO	I	Unused pin
24	VCOM	FM VCO	I	FM VCO input
25	VCOL	AM VCO	I	AM VCO input
26	VSS1		—	GND
27	EO1		O	Unused pin
28	EO2		O	PLL error output pin
29	CE	CE	I	Detects power supply line status. Power supply line OFF : Low Power supply line ON : High
30	X0		O	Crystal oscillator connection pin
31	X1		I	
32	VSS4		—	Pin for regulator circuit capacitor connection to attain stable drive voltage of the oscillator
33	PA3	ALARM OUT	—	Connected to +3V.
34	PA2	WEATHER	O	Unused pin
35	PA1	TVL. LW	O	Unused pin
36	PA0	AM	O	BAND output pin. Low : FM, High : AM
37	PB3	CST OUT	—	Unused pin
38	PB2	POWER OUT	O	Unused pin
39	PB1	INT OUT	O	INITIALIZE Output
40	PB0	TVH. WEATHER	O	Unused pin
41	PC3	KEY SOURCE	O	Unused pin

Pin No.	Pin Name	Signal Name	I/O	Description
42-44	PC2-PC0	KEY SOURCE	O	<p>Conducts Key Scan. Timing chart (Ex.) When the PC2 line key is pressed.</p>
45	K3	KEY RETURN	I	Unused pin
46-48	K2-K0	KEY RETURN	I	<p>Key Return input Key Scan</p> <ol style="list-style-type: none"> ① Set PC0, PC1 and PC2 to "High". ② When noe of the 15 keys is pressed, PC0-PC2 will be set to "Low". ③ Each port is set to "High" (Key scan) in the following order PC0 → PC1 → PC2 to determine the pressed key. <p>K0-K3 input condition The figure in the right indicates that the key following PC1 is pressed.</p> <p>* When the initial key is pressed and held down while the next key is pressed, the second key input will not be accepted until the initial key is released (for +, - keys only). Release the initial key and press the next key so that the second key input will be accepted.</p>
49	NC		—	Connected to INITIALIZE
50	NC		—	Connected to GND.
51-56	LCD16-LCD11	LCD16-LCD11	O	LCD drive segment signal

4-1. SEMICONDUCTOR LEAD LAYOUTS

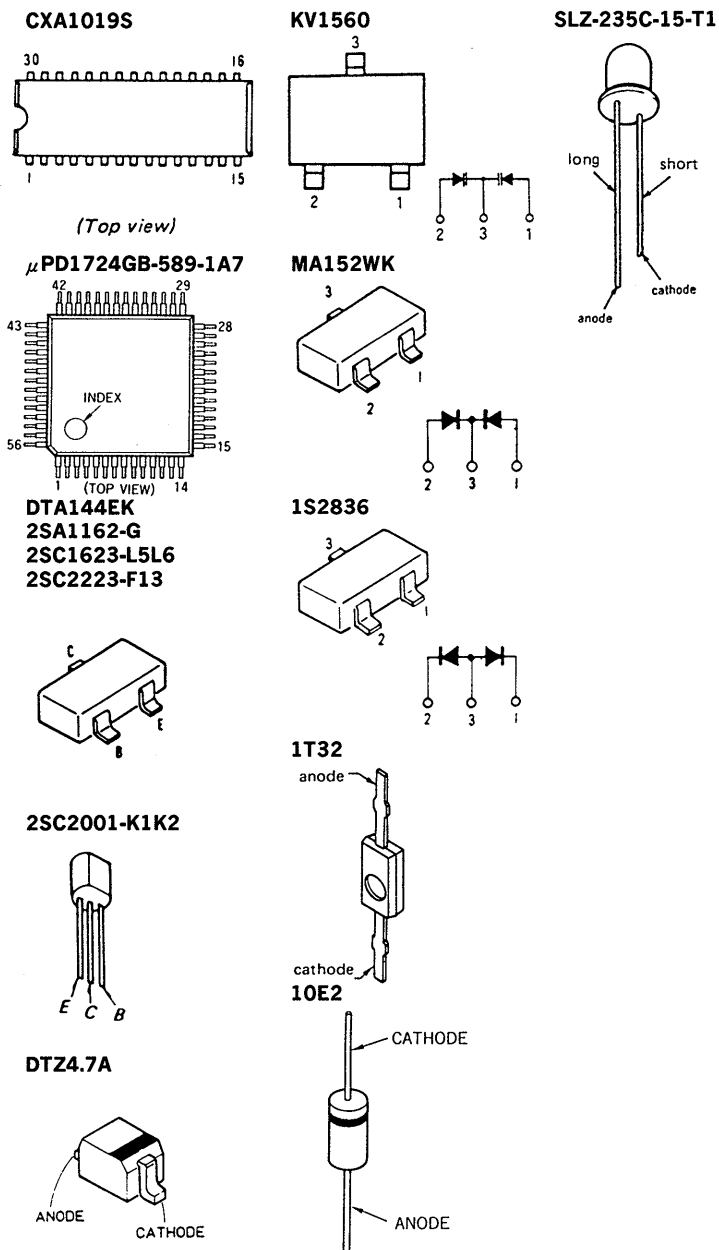

• Semiconductor Location

Ref. No.	Location
D2	D-3
D4	E-5
D5	E-4
D6	H-4
D7	G-5
D8	E-7
D9	H-4
D101	G-13
D102	G-12
D103	G-12
D104	G-11
D105	H-14
D107	H-13
D108	H-14
D109	H-14
D110	H-14
D111	H-14
IC1	F-5
IC101	H-12
Q6	D-4
Q8	F-3
Q9	F-5
Q11	G-4
Q12	H-4
Q101	H-11
Q102	H-10
Q103	I-12
Q104	I-12

Note:
 • ○ : parts extracted from the component side.
 • □ : indicates side identified with part number.

4-2. PRINTED WIRING BOARDS

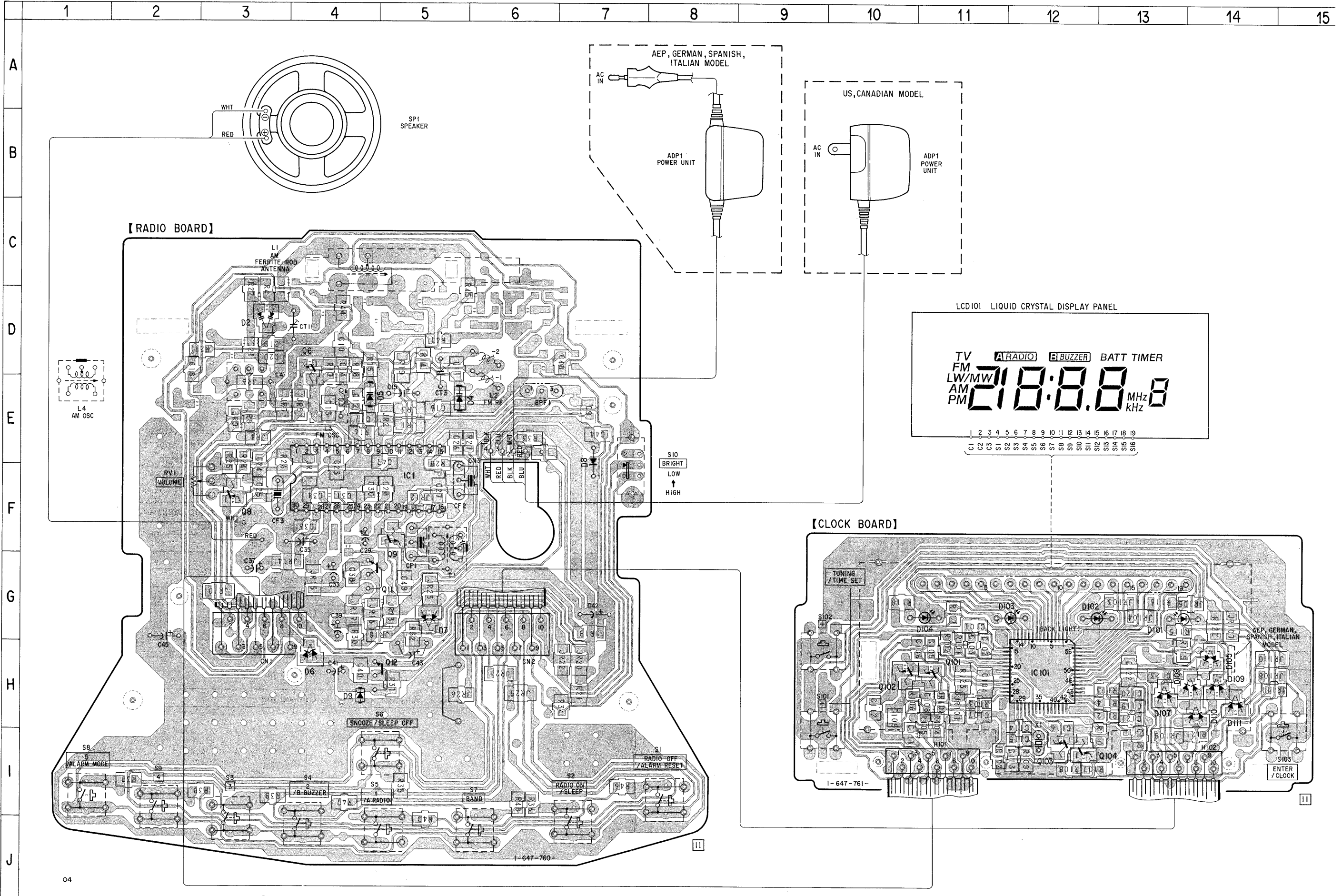

4-3. SCHEMATIC DIAGRAM

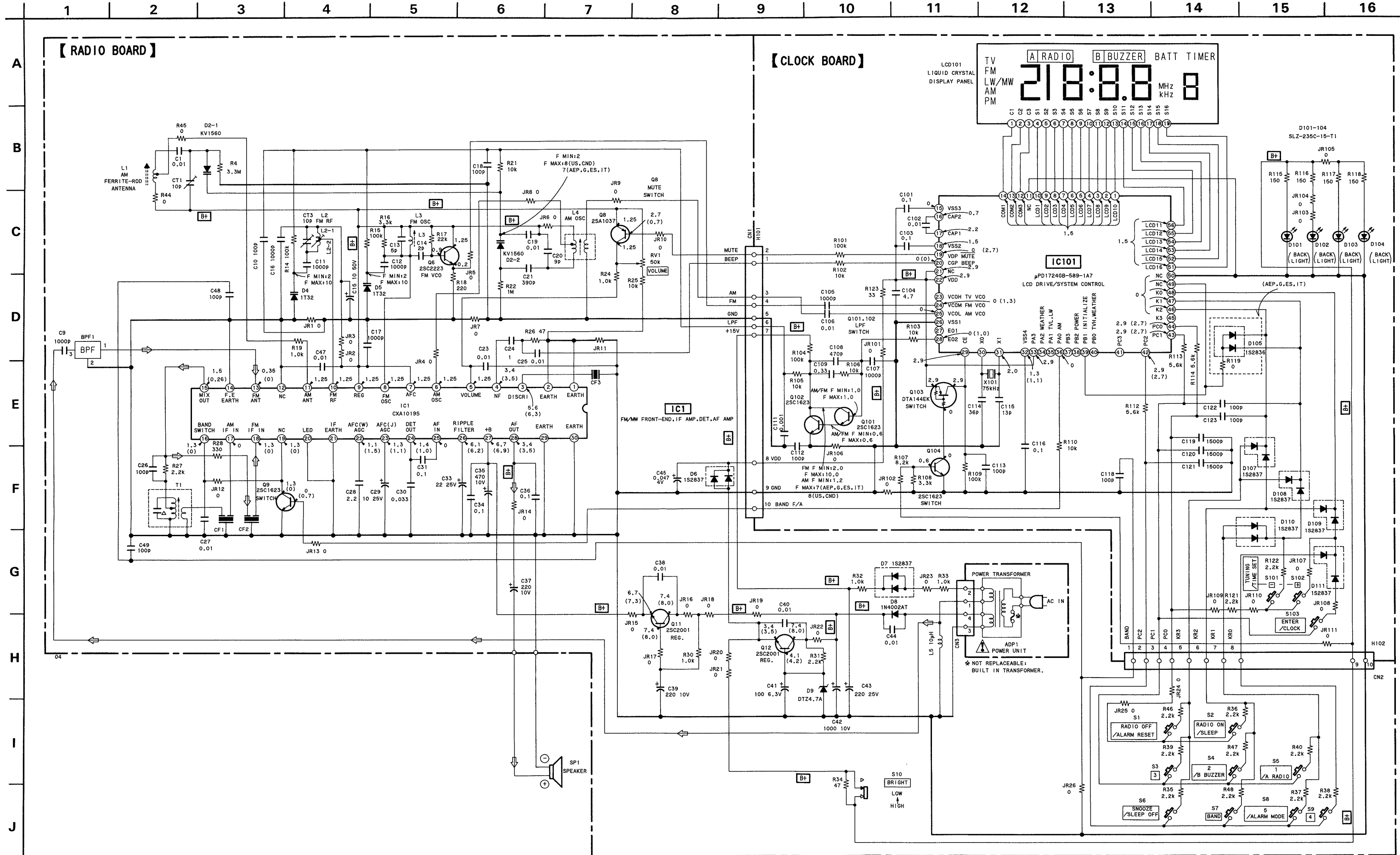

• IC Block Diagram
IC1 CX1019S

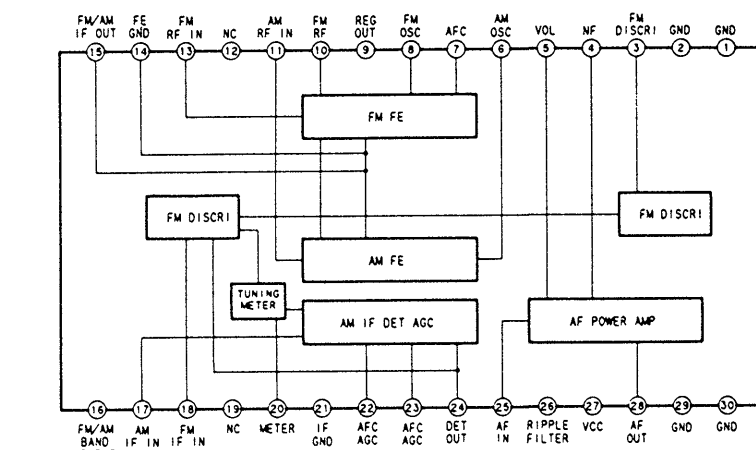

Note:

- All capacitors are in μF unless otherwise noted. pF : μF 50WV or less are not indicated except for electrolytics and tantalums.
- All resistors are in Ω and $\frac{1}{4}\text{W}$ or less unless otherwise specified.
- Δ : internal component.

Note: The components identified by mark Δ or dotted line with mark Δ are critical for safety. Replace only with part number specified.

Note: Les composants identifiés par une marque Δ sont critiques pour la sécurité. Ne les remplacer que par une pièce portant le numéro spécifié.

- Voltage is dc with respect to ground under no-signal (detuned) conditions. no mark: FM (): AM
- Voltages are taken with a VOM (Input Impedance $10\text{M}\Omega$). Voltage variations may be noted due to normal production tolerances.
- Signal path. \Rightarrow : FM
- Abbreviations
CND: Canadian model
G: German model
ES: Spanish model
IT: Italian model

CLOCK

RADIO

Ref. No.	Part No.	Description	Remark
R122	1-216-206-00	METAL GLAZE 2.2K 5%	1/8W
R123	1-216-162-00	METAL GLAZE 33 5%	1/8W
< SWITCH >			
S101	1-553-856-00	SWITCH, KEY BOARD (- (TUNING/TIME SET))	
S102	1-553-856-00	SWITCH, KEY BOARD (+ (TUNING/TIME SET))	
S103	1-553-856-00	SWITCH, KEY BOARD (ENTER/CLOCK)	
< VIBRATOR >			
X101	1-567-769-11	VIBRATOR, CRYSTAL (75kHz)	

*	A-3661-820-A	RADIO BOARD, COMPLETE (AEP, G, ES, IT)	
*	A-3661-859-A	RADIO BOARD, COMPLETE (US, Canadian)	

< FILTER >			
BPF1	1-239-061-11	FILTER, BAND PASS	
< CAPACITOR >			
C1	1-163-031-11	CERAMIC CHIP 0.01uF	50V
C9	1-163-141-00	CERAMIC CHIP 0.001uF	5% 50V
C10	1-163-117-00	CERAMIC CHIP 100PF	5% 50V
C11	1-163-141-00	CERAMIC CHIP 0.001uF	5% 50V
C12	1-163-141-00	CERAMIC CHIP 0.001uF	5% 50V
C13	1-163-088-00	CERAMIC CHIP 5PF	50V
C14	1-163-085-00	CERAMIC CHIP 2PF	50V
C15	1-124-907-11	ELECT 10uF	20% 50V
C16	1-163-141-00	CERAMIC CHIP 0.001uF	5% 50V
C17	1-163-141-00	CERAMIC CHIP 0.001uF	5% 50V
C18	1-163-117-00	CERAMIC CHIP 100PF	5% 50V
C19	1-163-031-11	CERAMIC CHIP 0.01uF	50V
C20	1-163-092-00	CERAMIC CHIP 9PF	0.25PF 50V
C21	1-163-131-00	CERAMIC CHIP 390PF	5% 50V
C23	1-164-232-11	CERAMIC CHIP 0.01uF	50V
C24	1-164-346-11	CERAMIC CHIP 1uF	16V
C25	1-163-031-11	CERAMIC CHIP 0.01uF	50V
C26	1-163-117-00	CERAMIC CHIP 100PF	5% 50V
C27	1-164-232-11	CERAMIC CHIP 0.01uF	50V
C28	1-164-505-11	CERAMIC CHIP 2.2uF	16V
C29	1-124-907-11	ELECT 10uF	20% 50V
C30	1-163-989-11	CERAMIC CHIP 0.033uF	10% 25V
C31	1-164-004-11	CERAMIC CHIP 0.1uF	10% 25V
C33	1-126-233-11	ELECT 22uF	20% 50V
C34	1-164-004-11	CERAMIC CHIP 0.1uF	10% 25V
C35	1-124-472-11	ELECT 470uF	20% 10V
C36	1-164-004-11	CERAMIC CHIP 0.1uF	10% 25V
C37	1-126-176-11	ELECT 220uF	20% 10V
C38	1-163-031-11	CERAMIC CHIP 0.01uF	50V

Ref. No.	Part No.	Description	Remark
C39	1-126-176-11	ELECT 220uF	20% 10V
C40	1-163-031-11	CERAMIC CHIP 0.01uF	50V
C41	1-124-584-00	ELECT 100uF	20% 10V
C42	1-126-926-11	ELECT 1000uF	20% 10V
C43	1-128-483-11	ELECT 220uF	20% 25V
C44	1-163-031-11	CERAMIC CHIP 0.01uF	50V
C45	1-125-701-11	CAP, DOUBLE LAYER 0.047F	5.5V
C47	1-164-232-11	CERAMIC CHIP 0.01uF	50V
C48	1-163-117-00	CERAMIC CHIP 100PF	5% 50V
C49	1-163-117-00	CERAMIC CHIP 100PF	5% 50V
< FILTER >			
CF1	1-577-072-21	FILTER, CERAMIC	
CF2	1-579-312-81	FILTER, CERAMIC	
CF3	1-579-312-81	FILTER, CERAMIC	
< CONNECTOR >			
* CN1	1-566-904-11	HOUSING, CONNECTOR 10P	
* CN2	1-566-904-11	HOUSING, CONNECTOR 10P	
* CN3	1-566-779-11	PIN, CONNECTOR 4P	
< TRIMMER >			
CT1	1-141-304-21	CAP, TRIMMER 10PF	
CT3	1-141-304-21	CAP, TRIMMER 10PF	
< DIODE >			
D2	8-719-951-05	DIODE KV1560	
D4	8-719-949-46	DIODE 1T32	
D5	8-719-949-46	DIODE 1T32	
D6	8-719-400-18	DIODE MA152WK	
D7	8-719-400-18	DIODE MA152WK	
D8	8-719-200-02	DIODE 10E2	
D9	8-719-976-94	DIODE DT74.7A	
< IC >			
IC1	8-752-035-29	IC CXA1019S	
< JUMPER RESISTOR >			
JR1-3	1-216-296-91	METAL GLAZE 0	5% 1/8W
JR4	1-216-295-00	METAL CHIP 0	5% 1/10W
JR5	1-216-296-91	METAL GLAZE 0	5% 1/8W
JR6	1-216-295-00	METAL CHIP 0	5% 1/10W
JR7	1-216-296-91	METAL GLAZE 0	5% 1/8W
JR8	1-216-296-91	METAL GLAZE 0	5% 1/8W
JR9	1-216-295-00	METAL CHIP 0	5% 1/10W
JR10	1-216-296-91	METAL GLAZE 0	5% 1/8W
JR11	1-216-296-91	METAL GLAZE 0	5% 1/8W
JR12	1-216-295-00	METAL CHIP 0	5% 1/10W

Ref. No.	Part No.	Description	Remark		
JR13-17	1-216-296-91	METAL GLAZE	0	5%	1/8W
JR18	1-216-295-00	METAL CHIP	0	5%	1/10W
JR19-25	1-216-296-91	METAL GLAZE	0	5%	1/8W
JR26	1-216-295-00	METAL CHIP	0	5%	1/10W
< COIL >					
L1	1-402-616-11	ANTENNA, FERRITE-ROD (MW)			
L2-1	1-406-827-11	COIL, AIR-CORE			
L2-2	1-406-826-11	COIL, AIR-CORE			
L3	1-460-335-11	COIL (WITH CORE)			
L4	1-406-485-11	COIL (OSC)			
L5	1-412-006-31	INDUCTOR CHIP	10uH		
< TRANSISTOR >					
Q6	8-729-102-07	TRANSISTOR	2SC2223-F13		
Q8	8-729-216-22	TRANSISTOR	2SA1162-G		
Q9	8-729-120-28	TRANSISTOR	2SC1623-L5L6		
Q11	8-729-011-92	TRANSISTOR	2SC2001-K1K2		
Q12	8-729-011-92	TRANSISTOR	2SC2001-K1K2		
< RESISTOR >					
R4	1-216-133-00	METAL CHIP	3.3M	5%	1/10W
R14	1-216-097-00	METAL CHIP	100K	5%	1/10W
R15	1-216-097-00	METAL CHIP	100K	5%	1/10W
R16	1-216-061-00	METAL CHIP	3.3K	5%	1/10W
R17	1-216-081-00	METAL CHIP	22K	5%	1/10W
R18	1-216-033-00	METAL CHIP	220	5%	1/10W
R19	1-216-198-00	METAL CHIP	1K	5%	1/8W
R21	1-216-073-00	METAL CHIP	10K	5%	1/10W
R22	1-216-121-00	METAL CHIP	1M	5%	1/10W
R24	1-216-049-00	METAL CHIP	1K	5%	1/10W
R25	1-216-073-00	METAL CHIP	10K	5%	1/10W
R26	1-216-017-00	METAL CHIP	47	5%	1/10W
R27	1-216-057-00	METAL CHIP	2.2K	5%	1/10W
R28	1-216-037-00	METAL CHIP	330	5%	1/10W
R30	1-216-049-00	METAL CHIP	1K	5%	1/10W
R31	1-216-057-00	METAL CHIP	2.2K	5%	1/10W
R32	1-216-049-00	METAL CHIP	1K	5%	1/10W
R33	1-216-049-00	METAL CHIP	1K	5%	1/10W
R34	1-216-017-00	METAL CHIP	47	5%	1/10W
R35-40	1-216-057-00	METAL CHIP	2.2K	5%	1/10W
R44	1-216-295-00	METAL CHIP	0	5%	1/10W
R45	1-216-295-00	METAL CHIP	0	5%	1/10W
R46-48	1-216-057-00	METAL CHIP	2.2K	5%	1/10W

Ref. No.	Part No.	Description	Remark
< VARIABLE RESISTOR >			
RV1	1-241-542-11	RES, VAR, CRABON (VOLUME)	
< SWITCH >			
S1	1-571-977-11	SWITCH, TACTIL (RADIO OFF/ALARM RESET)	
S2	1-571-977-11	SWITCH, TACTIL (RADIO ON/SLEEP)	
S3	1-571-977-11	SWITCH, TACTIL (3)	
S4	1-571-977-11	SWITCH, TACTIL (2/B BUZZER)	
S5	1-571-977-11	SWITCH, TACTIL (1/A RADIO)	
S6	1-571-977-11	SWITCH, TACTIL (SNOOZE/SLEEP OFF)	
S7	1-571-977-11	SWITCH, TACTIL (BAND)	
S8	1-571-977-11	SWITCH, TACTIL (5/ALARM MODE)	
S9	1-571-977-11	SWITCH, TACTIL (4)	
S10	1-571-478-11	SWITCH, SLIDE (BRIGHT)	
< TRANSFORMER >			
T1	1-404-790-11	TRANSFORMER, IF	

MISCELLANEOUS			

△ADP1	1-467-055-11	POWER UNIT (US, Canadian)	
△ADP1	1-467-056-11	POWER UNIT (AEP, G, ES, IT)	
SP1	1-503-616-11	SPEAKER	

ACCESSORIES & PACKING MATERIALS			

	1-501-499-11	COUPLER, ANTENNA (AEP)	
	3-756-705-11	MANUAL, INSTRUCTION (ENGLISH, FRENCH, GERMAN, SPANISH) (US, Canadian, AEP, G, ES)	
	3-756-705-41	MANUAL, INSTRUCTION (ITALIAN, PORTUGUESE, DUTCH, SWEDISH) (AEP, IT)	
*	3-904-703-01	INDIVIDUAL CARTON (Canadian, AEP, G, ES, IT)	
*	3-905-271-01	INDIVIDUAL CARTON (US)	

HARDWARE LIST			

#1	7-685-649-79	SCREW +P 3X14 TYPE2 NON-SLIT	

<p>The components identified by mark △ or dotted line with mark △ are critical for safety. Replace only with part number specified.</p>	<p>Les composants identifiés par une marque △ sont critiques pour la sécurité. Ne les remplacer que par une pièce portant le numéro spécifié.</p>
---	---

