

ICF-SW55

SERVICE MANUAL

US Model
 Canadian Model
 AEP Model
 UK Model
 E Model
 Australian Model



Specifications

Circuit system LW/MW/SW: Dual conversion super-heterodyne
 FM: Single conversion, superheterodyne

Frequency range

Type	Frequency coverage			
	FM*	LW	MW	SW
1	76.0-108MHz	150		29,999.9kHz
2	87.5-108MHz	150		29,999.9kHz
3	87.5-108MHz	150-285kHz	531	26,100kHz
4	87.5-108MHz	150-285kHz	531-1,602kHz	3,850-26,100kHz

*Stereo reception when using stereo earphones
 Type 1: Countries that are not listed below
 Type 2: Germany, Austria, and Scandinavian countries
 Type 3: Saudi Arabia
 Type 4: Italy

Intermediate frequency LW/MW/SW: 55.845MHz (first)
 455kHz (second)

Antennas

FM: 10.7MHz
 LW/MW: Built-in ferrite bar antenna
 SW/FM: Telescopic antenna
 Approx. 7.7 cm (3 1/8 inches) dia.
 400mW (at 10% harmonic distortion)
 Recording output jack (minijack)
 Output level 245 mV (-10dB)
 Output impedance 10 kilohms or less
 Earphones jack (stereo minijack)

Speaker Power output Outputs

Power requirements

6VDC
 For R6 (size AA) batteries
 DC IN 6V jack accepts:
 •supplied AC power adaptor

Where purchased	AC power adaptor	Operating voltage
Canadian model	AC-E602	110 - 120V / 220 - 240V AC, adjustable. 50 / 60Hz
US model	AC-E604	120V AC, 60Hz
UK model	AC-E603	240V AC, 50Hz
AEP, Germany, French, E, Saudi Arabia, Italian model	AC-E600	110 - 120V / 220 - 240V AC, adjustable 50 / 60Hz

Battery life

•DCC-E160L car battery cord (not supplied) for use with 12V car battery
 Approx. 10 hours (FM reception)
 Approx. 7 hours (AM reception)
 listening for four hours a day at normal volume, using Sony SUM-3 (NS) batteries.
 194 x 127 x 39 mm (w/h/d)
 (7 3/4 x 5 x 1 5/16 inches) including projecting parts and controls with antenna retracted
 Approx. 900g (approx. 2lb) including batteries

Dimensions

Weight

- Continued on page 2 -

LW/MW/SW/FM STEREO
 PLL SYNTHESIZED RECEIVER
SONY®



Downloaded by
 RadioAmateur.EU



TABLE OF CONTENTS

- Accessories supplied**
- AC power adaptor* (1)
 - AC plug adaptor* (1)
 - Stereo earphones (1)
 - Earpad (2)
 - System carrying case (1)
 - Carrying case (1)
 - SW compact antenna (1)
 - External antenna connector (1)
 - "Wave Handbook" only English version(1)
 - "How to Catch the Wave" only English version (1)
 - Quick reference (1)
 - Preset frequency list (1)
 - * Not provided with certain models

Design and specifications subject to change without notice.

<u>Section</u>	<u>Title</u>	<u>Page</u>
	Specification	1
1. GENERAL		
	Location and Function of Controls	3
	Setting the Clock	6
	Preset Station Tuning	9
	Direct Tuning	10
	Manual Tuning	11
	Scan Tuning	13
	Memorizing Stations	15
	How to Set the Timer	17
	How to Set the Alarm	19
	Sleep Timer Operation	21
2. DISASSEMBLY		22
	2-1. Removal Rear Cabined	22
	2-2. Removal LCD	22
	2-3. Removal KEY Board	22
3. PORT FUNCTIONS DISCRPTION		23
4. ELECTRICAL ADJUSTMENTS		24
5. DIAGRAMS		25
	5-1. Block Diagram	27
	5-2. Printed Wiring Board – SIGNAL SECTION –	30
	5-3. Schematic Diagrams – SIGNAL SECTION –	35
	5-4. Schematic Diagrams – MICRO COMPUTER SECTION –	39
	5-5. Printed wiring Boards – MICRO COMPUTER SECTION –	43
6. EXPLODED VIEWS		
	6-1.	49
	6-2.	50
	6-3.	51
7. ELECTRICAL PART LIST		52

SAFETY-RELATED COMPONENT WARNING!!

COMPONENTS IDENTIFIED BY MARK  OR DOTTED LINE WITH MARK  ON THE SCHEMATIC DIAGRAMS AND IN THE PARTS LIST ARE CRITICAL TO SAFE OPERATION. REPLACE THESE COMPONENTS WITH SONY PARTS WHOSE PART NUMBERS APPEAR AS SHOWN IN THIS MANUAL OR IN SUPPLEMENTS PUBLISHED BY SONY.

ATTENTION AU COMPOSANT AYANT RAPPORT À LA SÉCURITÉ!

LES COMPOSANTS IDENTIFIÉS PAR UNE MARQUE  SUR LES DIAGRAMMES SCHÉMATIQUES ET LA LISTE DES PIÈCES SONT CRITIQUES POUR LA SÉCURITÉ DE FONCTIONNEMENT. NE REMPLACER CES COMPOSANTS QUE PAR DES PIÈCES SONY DONT LES NUMÉROS SONT DONNÉS DANS CE MANUEL OU DANS LES SUPPLÉMENTS PUBLIÉS PAR SONY.

SECTION 1 GENERAL

This section is extracted from instruction manual.

Location and Function of Controls

See the pages indicated in ● for details.

Front and Right Side Panel

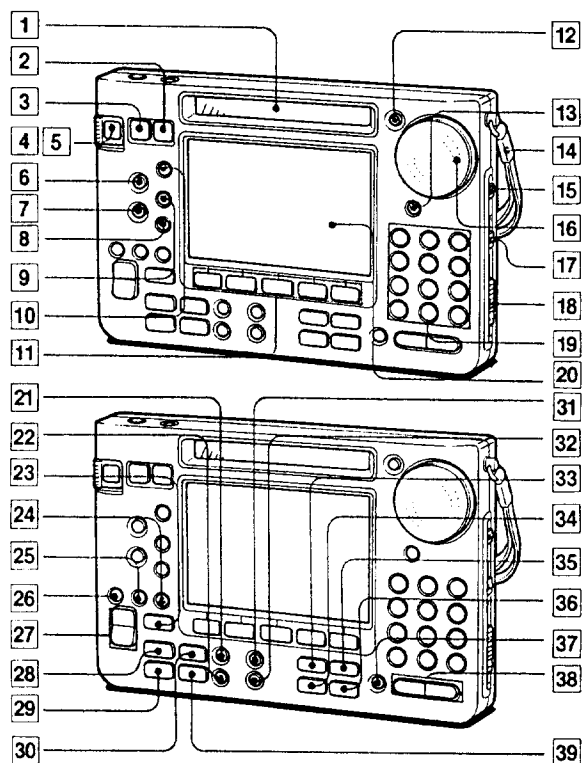



- 1. Speaker duct
- 2. STANDBY button ●³⁹
- 3. SLEEP (sleep timer) button ●⁴⁶
- 4. ON/OFF (power) button
- 5. POWER/LOCK switch
Set this switch to POWER, then press the ON/OFF button to turn on the radio. Set the switch to LOCK when carrying the radio. When this switch is set to LOCK, the power will not turn on nor the timer activate even if you accidentally press the ON/OFF button.
- 6. NIGHT/TIME DIFF (night/time difference) button ●²⁰
- 7. WORLD TIME button ●¹⁹
- 8. SUMMER (summer time or "daylight saving time") ON/OFF button ●¹⁵
- 9. TIME DIFF SET (time difference set) button ●¹⁵
- 10. UTC/LOCAL (Universal Time Coordinated/local) button ●¹⁵
- 11. M1, M2, M3, M4, M5 (memory 1–5) buttons ●²¹

- 12. KEY PROTECT \leftrightarrow button ●²⁴
While this button is pressed, all the functions of the buttons and dial are locked.
- 13. FAST/SLOW/LOCK (dial tuning mode and lock) button ●²⁵ ●²⁶
- 14. Hand strap
- 15. MONO STEREO (monoaural/stereo) selector ●²⁴
- 16. TUNE/JOG dial
- 17. TONE selector ●²⁴
MUSIC: for listening to music
NORM: for normal listening
NEWS: for listening to news
- 18. VOLUME control ●²¹
- 19. DIRECT TUNING numeric buttons/letter, \odot (hours) and EXE (execute) buttons ●²³ ●³⁶ ●⁴²
- 20. Display window
- 21. START TIME button ●³⁸
- 22. ALARM TIME button ●⁴²
- 23. LAST PAGE button ●³⁴
- 24. ERASE button ●³³
- 25. ENTER button ●⁴²
- 26. CHECK button ●³³
- 27. PAGE FEED +/- buttons ●²¹
- 28. TIMER MEMORY button ●³²
- 29. AM FUNCTION button ●²⁷ ●²⁸
- 30. TIMER SET button ●³⁷
- 31. OPR TIME (operation time) button ●³⁹
- 32. BEEP TYPE button ●⁴³
- 33. FM (ABC...) button ●²⁴ ●³⁶
- 34. AM BAND - (DELETE) button ●²⁶ ●³⁶
- 35. AM (123...) button ●²³ ●³⁶
- 36. AM BAND + (INSERT) button ●²⁶ ●³⁶
- 37. LABEL EDIT button ●³⁵
- 38. STEP/SCAN buttons ●²⁶
- 39. ALARM SET button ●⁴²

Location and Function of Controls

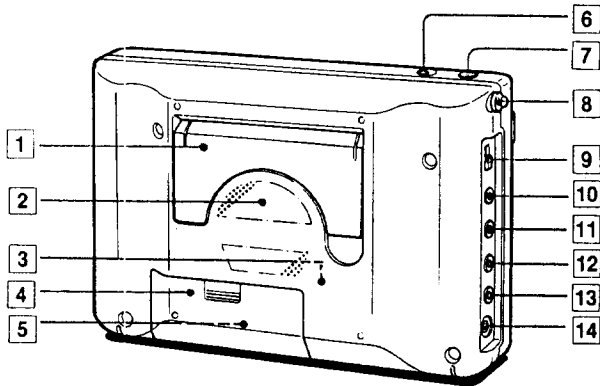
Rear, Left Side and Upper Panel



- 1 Stand 9
- 2 Speaker
- 3 Buzzer
- 4 Battery compartment 12
- 5 Reset button (inside the battery compartment)
Press this button with something like a toothpick, when the unit functions incorrectly because of an electric discharge caused by static electricity, etc.
When this button is pressed, all the memorized data except for the page memory (pages from 1 to 25) will be erased.
- 6 TIME SET button 15
- 7 LIGHT/BATT CHECK (light/battery check) button 12
Press to illuminate the display window for about 15 seconds or to check the battery condition. The duration of the illumination is prolonged while you operate the unit. To put off, press this button again.
- 8 Telescopic antenna 22
- 9 AM SENS (AM sensitivity) selector 24
- 10 AM EXT ANT (AM external antenna) jack 48
- 11 TAPE REMOTE jack 51
- 12 TAPE LINE OUT jack (stereo mini jack) 50 51
- 13  (stereo earphones) jack
Connect the stereo earphones for private listening.
- 14 DC IN 6V  (external power input) jack 14

8

How to use the stand

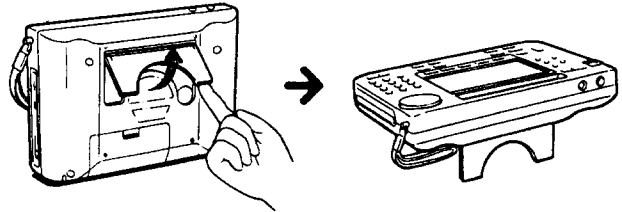

9

Location and Function of Controls

Clock/Timer Display

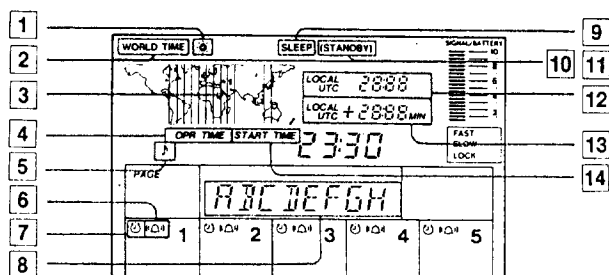

- 1 ✱ Summer time indication 15
- 2 WORLD TIME indication 19
- 3 Night indication and area (time difference) indication 20
- 4 OPR TIME (operation time) indication 38
Appears when the time length of the timer operation is set.
- 5 ♪ Beep indication 42
- 6 📞 Alarm indication 43
- 7 ⌚ Timer indication 38 39
- 8 LABEL display – TIMER (M) (timer memory), *TIMER* (timer setting), memorized title labels, city names, time difference from UTC, appear.
- 9 SLEEP indication 40
Appears when the timer or sleep timer is activated.
- 10 STANDBY (timer or alarm standby) indication 39
Appears when the timer or alarm is reserved.
- 11 (STANDBY) indication 39
() appears when you set the timer or alarm (or adjust the current time or the time difference) after the unit has been set in the standby condition by pressing the STANDBY button. When (STANDBY) appears, timer or alarm will not activate.
- 12 LOCAL/UTC current time indication
Indication changes between LOCAL current time and the UTC current time by pressing the UTC/LOCAL button.
- 13 Time difference indication and remaining time indication of the timer
The meaning of the time difference differs according to LOCAL or UTC indication. (LOCAL indication appears while WORLD TIME is pressed.)
LOCAL: Indicates the time difference between your local time and the time in some other area in the world.
UTC: Indicates the time difference between UTC (Universal Time Coordinated) and your local time.
- 14 START TIME indication 38
Appears when the starting time of the timer or alarm is set.

10

Radio Reception Display and Others

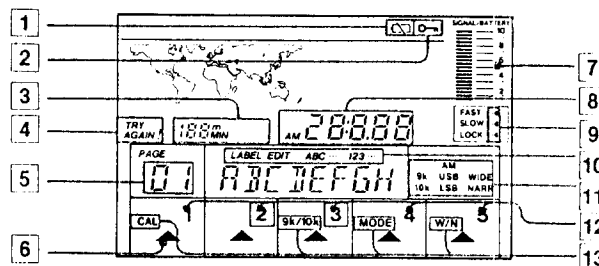

- 1 🔋 Battery empty indication 12
- 2 🔑 Key protect indication 24
While this indication appears, all the functions of the buttons and dial are locked.
- 3 AM band and SW meter band
- 4 TRY AGAIN! indication 24
Appears when the frequency outside the frequency range is input.
- 5 PAGE number, AL (alarm) FU (AM function) incication
- 6 ▲ indication
Indicates the memory which is being selected.
- 7 SIGNAL/BATTERY (signal strength/battery) meter 14
- 8 Band, frequency and CAL indication
CAL appears when power is supplied or when calibration adjustment is made.
- 9 FAST SLOW LOCK (dial tuning mode) indication 26
- 10 LABEL EDIT indication 35
- 11 AM mode indication
9kHz or 10kHz MW channel step indication
AM USB LSB indication
WIDE NARR (wide or narrow selectivity) indication
- 12 Memories (1 to 5)
The numbers (from 1 to 5) correspond to memory buttons (M1 to M5). A frame appears around a memory number when the station is preset in that memory.
- 13 AM function indication
CAL (calibration), 9k/10k, MODE (AM, USB or LSB mode), W/N (wide or narrow selectivity).

11

Setting the Clock

Before setting the clock, check the time difference between the local time in your area and the UTC time by referring to the table in page 16. Some city names and their time difference from UTC are already memorized at the factory.

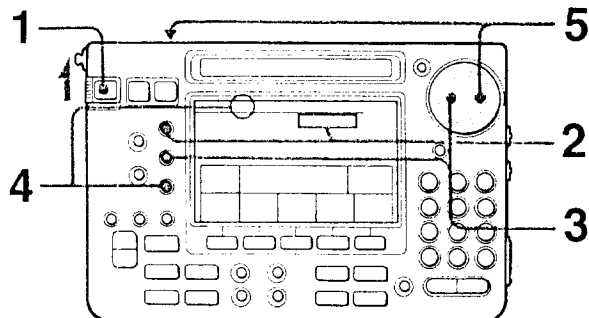

- 1 Set POWER/LOCK to POWER.
- 2 Check the current time indication.
When the LOCAL current time appears, skip this step.
When the UTC current time appears, press UTC/LOCAL button.
- 3 While pressing TIME DIFF SET, turn the TUNE/JOG dial until your city name or the time difference* between your local time and the UTC time appears.

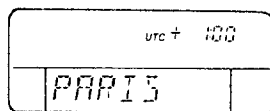

While pressing TIME DIFF SET, the ☀ indication (if already displayed) disappears temporarily.

- 4 When "summer time" is not used in your area or ☀ is already displayed, skip this step.
Press SUMMER ON/OFF if your area is now in the "summer time" period (under daylight saving time).
☀ appears.
- 5 While pressing TIME SET, turn the TUNE/JOG dial to adjust the current local time.
The clock starts operating.

Notes

- When pressing TIME SET, city name or time difference appears.
- Current UTC time is displayed when you press the UTC/LOCAL button. (UTC indication appears).

*Here, this means time difference during the standard time as shown in the table in page 16 (not under daylight saving time).

15

Setting the Clock

Zero second adjustment

If you want to adjust the time exactly to the second with a telephone time signal, proceed as in the following example.
Example: To set to 15:15

- 1 Adjust the time indication to 15:15 in step 5 in page 15, release TUNE/JOG but keep TIME SET pressed.
- 2 Release TIME SET simultaneously with the telephone time signal. The clock begins to show the precise time.

Note

Zero second adjustment is not made by pressing TIME SET only. Once turn the TUNE/JOG dial while pressing TIME SET.

Difference between local time and UTC (Universal Time Coordinated)

The table shows the difference between the local time and the UTC time in each area. The differences marked with a plus sign (+) indicate the number of hours ahead of the UTC. The differences marked with a minus sign (-) indicate the number of hours behind the UTC.

To see the time difference during the period for daylight saving time or "Summer Time" (if necessary), add one hour to the difference indicated in the table.

Area or city	Label preset	Time difference
Argentina		- 3:00
Buenos Aires	BUENOS A	- 3:00
Australia		
Sydney	SYDNEY	+ 10:00
Darwin		+ 9:30
Perth	PERTH	+ 8:00
Austria		+ 1:00
Vienna	VIENNA	+ 1:00
Bangladesh		+ 6:00
Dacca	DACCA	+ 6:00
Belgium		+ 1:00
Brussels	BRUSSELS	+ 1:00
Brazil		
Sao Paulo	SAO PAUL	- 3:00
Rio de Janeiro		- 3:00
Manaus		- 4:00
Canada		
Vancouver	VANCOUVE	- 8:00
Calgary	CALGARY	- 7:00
Toronto	TORONTO	- 5:00
Montreal	MONTREAL	- 5:00
Canary Islands	CANARY	+ 0:00
Chile		- 4:00
Santiago	SANTIAGO	- 4:00

16

Setting the Clock

Area or city	Label preset	Time difference
China (P.R.)		+ 8:00
Beijing	BEIJING	+ 8:00
Denmark		+ 1:00
Ecuador		- 5:00
Egypt		+ 2:00
Cairo	CAIRO	+ 2:00
Fiji Island	FIJI	+ 12:00
Finland		+ 2:00
Helsinki	HELSINKI	+ 2:00
France		+ 1:00
Paris	PARIS	+ 1:00
Germany		+ 1:00
Berlin	BERLIN	+ 1:00
Greece		+ 2:00
Athens	ATHENS	+ 2:00
Hawaii		- 10:00
Honolulu	HONOLULU	- 10:00
Hong Kong	HONGKONG	+ 8:00
India		+ 5:30
Calcutta	CALCUTTA	+ 5:30
Indonesia		
Jakarta	JAKARTA	+ 7:00
Iran		+ 3:30
Tehran	TEHRAN	+ 3:30
Italy		+ 1:00
Rome	ROME	+ 1:00
Japan		+ 9:00
Tokyo	TOKYO	+ 9:00
Kenya		+ 3:00
Nairobi	NAIROBI	+ 3:00
Korea (D.P.R.)		+ 9:00
Seoul	SEOUL	+ 9:00
Malaysia		+ 8:00
Mexico		
Tijuana		- 8:00
Acapulco	ACAPULCO	- 6:00
Mexico	MEXICO	- 6:00
Maldives	MALDIVES	+ 5:00
Netherlands		+ 1:00
Amsterdam	AMSTERDA	+ 1:00
New Caledonia		+ 11:00
Noumea	NOUMEA	+ 11:00
New Zealand		+ 12:00
Auckland	AUCKLAND	+ 12:00
Norway		+ 1:00
Pakistan		+ 5:00
Karachi	KARACHI	+ 5:00

Area or city	Label preset	Time difference
Panama		- 5:00
Panama	PANAMA	- 5:00
Peru		- 5:00
Lima	LIMA	- 5:00
Philippines		+ 8:00
Poland		+ 1:00
Portugal		+ 0:00
Saudi Arabia		+ 3:00
Riyadh	RIYADH	+ 3:00
Senegal		+ 0:00
Dakar	DAKAR	+ 0:00
Singapore	SINGAPOR	+ 8:00
Spain		+ 1:00
Madrid	MADRID	+ 1:00
Sri Lanka		+ 5:30
Sweden		+ 1:00
Stockholm	STOCKHOL	+ 1:00
Switzerland		+ 1:00
Zurich	ZURICH	+ 1:00
Tahiti Island		- 10:00
Taiwan		+ 8:00
Thailand		+ 7:00
Bangkok	BANGKOK	+ 7:00
United Arab Emirates		+ 4:00
Dubai	DUBAI	+ 4:00
United Kingdom		+ 0:00
London	LONDON	+ 0:00
USA		
Anchorage	ANCHORAG	- 9:00
San Francisco	SAN FRAN	- 8:00
Los Angeles	LOS ANGE	- 8:00
Denver	DENVER	- 7:00
Chicago	CHICAGO	- 6:00
Dallas	DALLAS	- 6:00
New York	NEW YORK	- 5:00
USSR		
Moscow	MOSCOW	+ 2:00
Venezuela		- 4:00
Caracas	CARACAS	- 4:00

For areas where "summer time" (daylight saving time) is used Press SUMMER ON/OFF during the summer time period to make ☀ appear, as stated in step 4 in page 16, and press again at the end of the summer time. The time indication will be changed automatically. When the clock has been set during the standard time period, press SUMMER ON/OFF at the beginning of the summer time. The time indication will change to the summer time indication.

How to Know the Current Time in Some Place in the World

Even while you are listening to the radio, you can know the time in some other place in the world without affecting the radio reception.

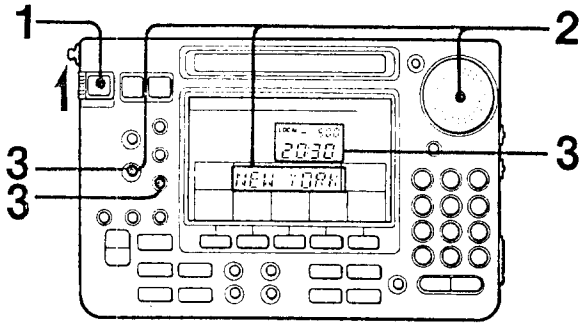

- 1 Set POWER/LOCK to POWER.
- 2 While pressing WORLD TIME, turn the TUNE/JOG dial until the desired city name or the time difference* between desired place and the UTC appears.

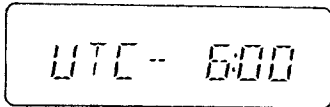

- 3 Keep pressing WORLD TIME. Keep pressing SUMMER ON/OFF if your desired place is in the summer time period. Read the time shown in the display. Also you can read the time difference between your local time and the time in your desired place, which is displayed just above the current time.



*Here, this means time difference as shown in the table in page 16.

Setting the Clock

How to Know the Night Area in the World

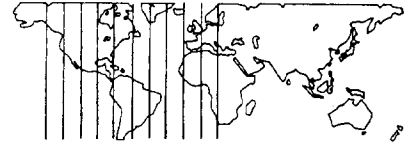

Press NIGHT/TIME DIFF.

The area on the world map where it is night (from about 18:00 to 6:00) will be shaded. This is useful as a reference for better reception of SW, because SW is received better in the nighttime than in the daytime.

When You Move from One Place to Another

Adjust the time difference only. Local time can be changed by adjusting the time difference.

Note

The UTC time, local time and the time difference are related to each other as follows:

$$(\text{Time difference}) = (\text{Local time}) - (\text{UTC time})$$

Preset Station Tuning

Once the frequencies of the stations are preset, you can tune in the station easily just by selecting the page and pressing the necessary memory button.
Some stations are already preset in this unit at the factory. Let's try to receive some of the preset stations.

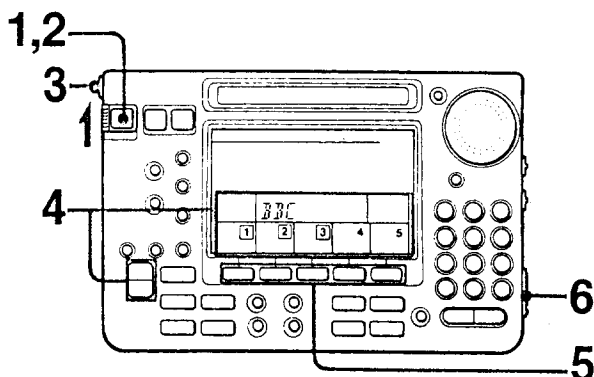

The illustration does not necessarily show the preset memory or station.

- 1 Set POWER/LOCK to POWER.
- 2 Press ON/OFF.
- 3 Extend the antenna. See page 20.
- 4 Press PAGE FEED + or - to find a page where a title label is already written.
A frame appears around the memory number.
- 5 Press an M1 – M5 which corresponds to the memory number inside a frame.
- 6 Adjust VOLUME.

After listening, turn off the radio by pressing ON/OFF.

You can also preset the stations according to your own preference. See page 17.

Notes

- Tuning conditions differ very much according to the area, time, broadcasting condition, etc., so you may not be able to tune in the station with these procedures. If you cannot, try another memory or page for another station.
- When power is supplied, calibration adjustment is made automatically. (CAL indication appears.) But, when transporting the unit to a place where the temperature is very different than before, proceed as follows:
 - 1 Press AM.
 - 2 Press AM FUNCTION.
 - 3 Press M1.
 AM calibration adjustment will be made in a moment.
 - 4 Press AM FUNCTION again.

21

Preset Station Tuning

To Improve Receiving Condition

Adjust the antenna as illustrated.

For LW/MW reception

Retract the telescopic antenna. The built-in ferrite bar antenna activates. Since this antenna is directional, rotate the unit horizontally for optimum direction.

For SW reception

Pull out the telescopic antenna to its full length and set it vertically.

For FM reception

Pull out the telescopic antenna to expose its swivel base and adjust its length, angle and direction.

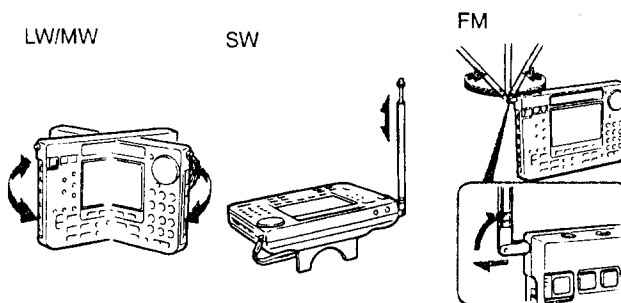

Notes

- Adjust the antenna within the range as illustrated. Be careful not to turn the antenna forcibly because it might be broken.
- If there is a fluorescent lamp just above the radio and the reception is noisy, keep the radio away from the lamp.
- If reception is unsatisfactory with the telescopic antenna or the built-in ferrite bar antenna, connect an external antenna for AM (LW/MW) and SW. See page 17 for details.
External antenna connection for FM cannot be done.
- In vehicles or buildings, radio reception may be difficult or noisy. Try listening near the window.
- If the received sound is distorted or noisy, adjust the antenna carefully.

22

Direct Tuning

If you know the frequency of a station to be received, you can tune in the station easily by direct tuning.

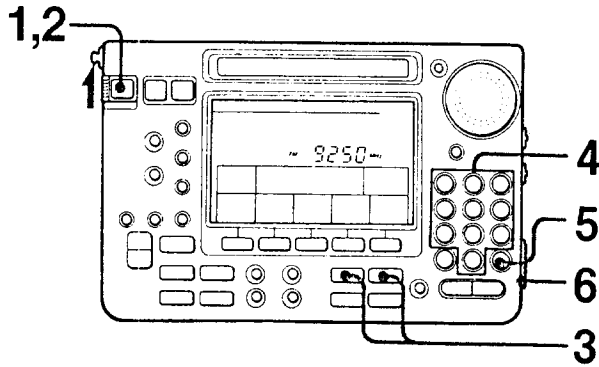

- 1 Set POWER/LOCK to POWER.
 - 2 Press ON/OFF.
 - 3 Select the desired band by pressing FM or AM. For LW, MW or SW, press AM.
 - 4 Input the frequency of the desired station by pressing DIRECT TUNING numeric buttons.
 - 5 Press EXE.
 - 6 Adjust VOLUME.
- After listening, turn off the radio by pressing ON/OFF.

To input a frequency

Example: AM 1,242kHz
 (AM) → ① → ② → ④ → ② → (EXE)

Example: FM 92.5MHz
 (FM) → ⑨ → ② → ⑤ → (EXE)

To input an AM frequency whose three digits are all 0

Example: AM 1,000kHz
 (AM) → ① → (EXE)

Example: AM 21,000kHz
 (AM) → ② → ① → (EXE)

Direct Tuning

Notes

- After pressing a numeric button, press next one within 5 seconds. If you do not, the indication will return to the previously received station.
- With direct tuning, the frequency is displayed in steps of the following intervals, depending on the band.
 AM: 1kHz
 FM: 0.05MHz
 If you input a frequency between the intervals, the frequency at the interval just below will be tuned in and displayed.
 For example, if you input FM 92.59MHz, FM 92.55MHz will be tuned in and displayed.

If "TRY AGAIN!" indication appears

You have input the frequency outside the frequency range. Try again to input the appropriate frequency.

If you notice a mistake while inputting

Press EXE once and input the frequency again.

On AM SENS selector

For AM reception, normally set AM SENS in the left side to NORM. If the received station is very weak, set it to DX and if received station is too strong to become distorted, set it to LOCAL.

On MONO STEREO selector (only for listening through stereo earphones)

For FM reception, normally set MONO STEREO in the right side to STEREO. When it is hard to hear the broadcast due to noise, set to MONO. The reception will be more stable and noise will be reduced. In this mode, there is no stereo effect.

When you are listening to the news

Set TONE in the right side to NEWS. Human voice will be heard more clearly. When you are listening to music, set it to MUSIC.

What is key protection?

When KEY PROTECT is pressed, appears on the display. While it is displayed, all the functions of the buttons and dial are locked, even though you can press or turn them. This prevents accidental change of the received station.

To release the key protection, press KEY PROTECT again.



Manual Tuning

Use manual tuning when you do not know the frequency of the station you want to tune in, or when you want to tune in judging with your own ears. There are two ways of tuning in: Dial tuning and Step tuning.

Dial Tuning

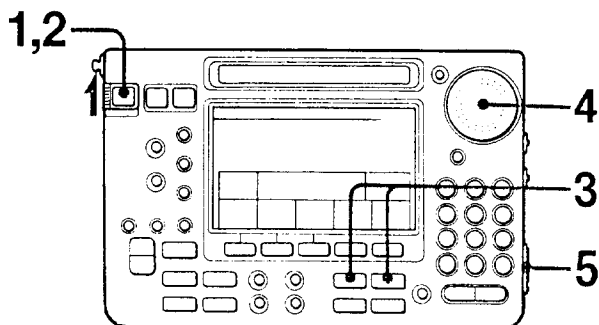

- 1 Set POWER/LOCK to POWER.
 - 2 Press ON/OFF.
 - 3 Select the desired band by pressing FM or AM. For LW, MW or SW reception, press AM.
 - 4 Turn the TUNE/JOG dial to search for the desired station. Turn the dial clockwise for higher frequencies and counterclockwise for lower frequencies.
 - 5 Adjust VOLUME.
- After listening, turn off the radio by pressing ON/OFF.

Notes

- The frequency changes in the following steps according to the dial tuning mode set to FAST or SLOW. Setting is adjusted by the FAST/SLOW/LOCK button.

	FAST	SLOW
FM	0.5MHz	0.05MHz
AM	1kHz	approx. 0.1kHz*

*Indication of each 0.1kHz does not appear.

- For AM reception in USB or LSB, set the tuning mode to SLOW and turn the TUNE/JOG dial slowly.

Manual Tuning

Step Tuning

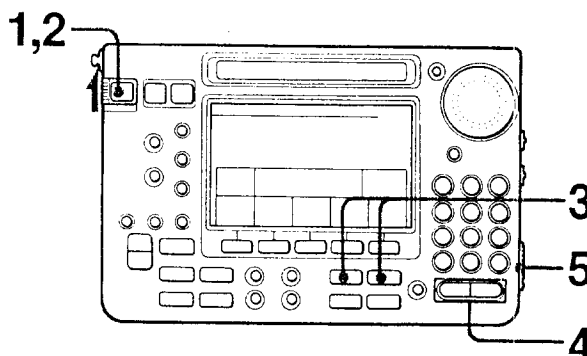

- 1 Set POWER/LOCK to POWER.
 - 2 Press ON/OFF.
 - 3 Select the desired band by pressing FM or AM. For LW, MW or SW reception, press AM.
 - 4 Press the STEP/SCAN -K or K+, to search for the desired station. One push changes the AM frequency in the steps shown in the table in page 25. Tune in the station more precisely with the TUNE/JOG dial. For FM, the frequency changes every 0.05MHz.
 - 5 Adjust VOLUME.
- After listening, turn off the radio by pressing ON/OFF.

How to use the AM BAND + or AM BAND - button

In AM reception, when you press this button, frequency indication will jump to the lowest frequency in the neighboring frequency range.

To prevent the frequency from fluctuating when the TUNE/JOG dial is accidentally touched

Set the dial tuning mode to LOCK by pressing FAST/SLOW/LOCK.

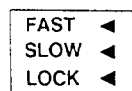

Manual Tuning

MW Channel Step

The MW channel step is factory-set to 9kHz or 10kHz to match the frequency allocation system of the country. If you use the radio where the frequency allocation system is based on the other interval, proceed as follows:

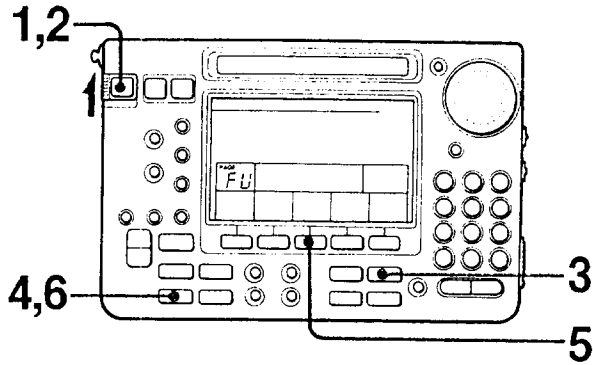

- 1 Set POWER/LOCK to POWER.
- 2 Press ON/OFF.
- 3 Press AM.
- 4 Press AM FUNCTION.
- 5 Press M3.
The channel step has been changed.
Display changes to 9k or 10k vice versa.
- 6 Press AM FUNCTION again.

The frequency allocation of the area

Area	Frequency allocation for MW
North America, South America	10kHz step
Other countries	9kHz step

Wide or Narrow Band Width in AM

Selectivity for this unit is adjusted WIDE or NARR (narrow) automatically according to the frequency input. But if the reception is poor because of too much noise or interference, proceed as follows:

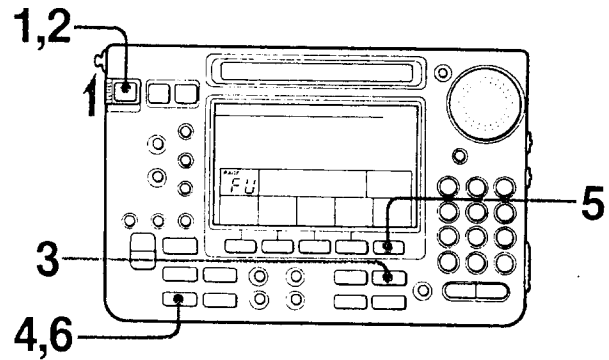

- 1 Set POWER/LOCK to POWER.
- 2 Press ON/OFF.
- 3 Press AM.
- 4 Press AM FUNCTION.
- 5 Press M5.
The indication changes to WIDE or NARR vice versa. The reception will be improved.
- 6 Press AM FUNCTION again.

Scan Tuning

To Receive the SSB (Single Side Band)

For SSB reception, proceed as follows:

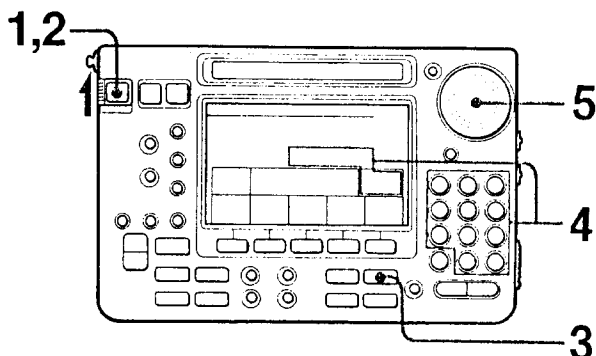

- 1 Set POWER/LOCK to POWER.
- 2 Press ON/OFF.
- 3 Press AM.
- 4 Input the frequency with DIRECT TUNING numeric buttons and EXE.
Display changes automatically to LSB or USB according to the frequency input.
Example: ⑦ → (EXE)

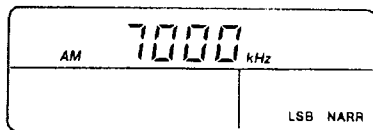

- 5 Turn the TUNE/JOG dial to find a station.
Finally tune in with the TUNE/JOG dial with the dial tuning mode set to SLOW.

If you want to manually change the display among LSB, USB or AM

Press AM FUNCTION, then press M4.

What is SSB?

SSB is very popular among ham and business radio and will be found on all of the amateur bands because of its signal intelligibility.

In general, SSB transmissions employ USB modulation, and for amateur bands lower than 10MHz, LSB is often used.

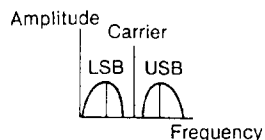

Use scan tuning to automatically scan the stations in the frequency range of a broadcast band.

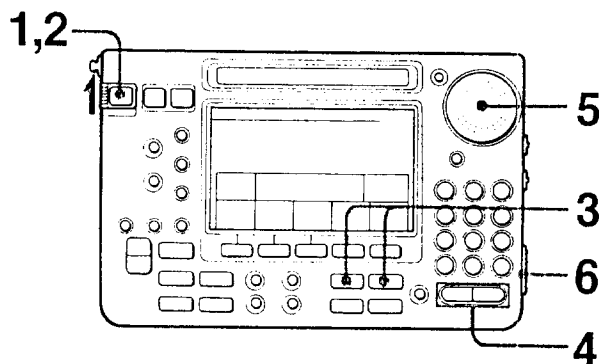

- 1 Set POWER/LOCK to POWER.
- 2 Press ON/OFF.
- 3 Select the desired band by pressing FM or AM.
- 4 Press STEP/SCAN -⏪ or ⏩ for about 1 second.
Within the frequency range of the table in page ⑩, scan tuning will begin and stop automatically when a station is received.
- 5 Tune in the station more precisely with the TUNE/JOG dial if necessary.
- 6 Adjust VOLUME.
After listening, turn off the radio by pressing ON/OFF.

Memorizing Stations

The frequency range and tuning interval of each broadcast band

Frequency (kHz)	Display (Meter band)	Repeat scan	Scanning interval	AM Mode
150 – 282	LW	Yes	3kHz	AM WIDE
283 – 530	LW		3kHz	AM WIDE
* 283 – 529	LW		3kHz	AM WIDE
531 – 1602	MW	Yes	9kHz	AM WIDE
* 531 – 1710	MW	Yes	10kHz	AM WIDE
1603 – 2249	SW		5kHz	USB NARROW
* 1711 – 2249	SW		5kHz	LSB NARROW
2250 – 2550	120m	Yes	5kHz	AM WIDE
2551 – 3149	SW		5kHz	USB NARROW
3150 – 3450	90m	Yes	5kHz	AM WIDE
3451 – 3499	SW		5kHz	USB NARROW
3500 – 3849	SW		5kHz	LSB NARROW
3850 – 4050	75m	Yes	5kHz	AM WIDE
4051 – 4699	SW		5kHz	USB NARROW
4700 – 5100	60m	Yes	5kHz	AM WIDE
5101 – 5899	SW		5kHz	USB NARROW
5900 – 6250	49m	Yes	5kHz	AM WIDE
6251 – 6999	SW		5kHz	USB NARROW
7000 – 7099	SW		5kHz	LSB NARROW
7100 – 7400	41m	Yes	5kHz	AM WIDE
* 7100 – 7400	SW		5kHz	LSB NARROW
7401 – 9399	SW		5kHz	USB NARROW
9400 – 10000	31m	Yes	5kHz	AM WIDE
10001 – 11499	SW		5kHz	USB NARROW
11500 – 12150	25m	Yes	5kHz	AM WIDE
12151 – 13499	SW		5kHz	USB NARROW
13500 – 13900	21m	Yes	5kHz	AM WIDE
13901 – 14999	SW		5kHz	USB NARROW
15000 – 15700	19m	Yes	5kHz	AM WIDE
15701 – 17449	SW		5kHz	USB NARROW
17450 – 18000	16m	Yes	5kHz	AM WIDE
18001 – 21449	SW		5kHz	USB NARROW
21450 – 21950	13m	Yes	5kHz	AM WIDE
21951 – 25599	SW		5kHz	USB NARROW
25600 – 26100	11m	Yes	5kHz	AM WIDE
26101 – 29999	SW		5kHz	USB NARROW

*When MW channel step is 10kHz.

Note

In some countries, it is impossible to receive some frequencies. The frequency ranges which can be received are indicated on the bottom exterior of your unit.

This section describes how to memorize stations for Preset Station Tuning.

Some stations are already preset at the factory.

Note on the page “00”

The preset stations memorized in page “00” can also be used as the memories for timer operation (see page 30.)

To memorize in page “00”, press TIMER MEMORY in the step 3 of the next section and do the same procedures as described.

How to Memorize a Station in the Pages

Up to 125 stations can be memorized in the pages from 1 to 25 (Each page accommodates 5 stations).

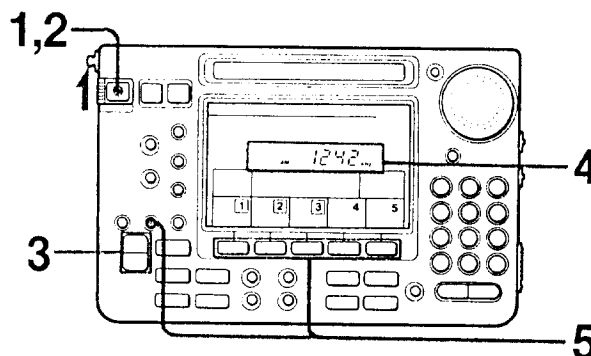

- 1 Set POWER/LOCK to POWER.
- 2 Press ON/OFF.
- 3 Press PAGE FEED + or – to select the desired page for memorizing.
- 4 Tune in the desired station by direct, manual or scan tuning. (See pages 23, 25 and 30.)
- 5 While pressing ENTER, press an M1 – M5 which corresponds to the memory number where you want to memorize.

A frame appears around the memory number which tells you that the memorizing has been completed.

Note

Frequency, AM/USB/LSB and AM band width (WIDE or NARR) are memorized.

Memorizing Stations

To check which station is memorized

While pressing CHECK, press an M1 to M5 whose memory should be checked. The frequency already preset in that memory is shown in the display independently of the station now being received.

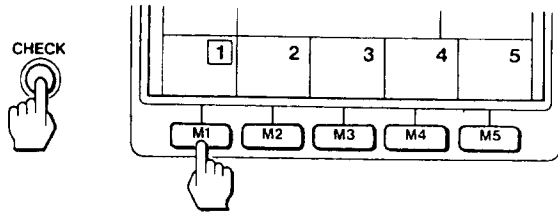

While the memory button is pressed, the SIGNAL meter indication disappears.

To erase the memorized station

If you memorize a station in the same memory (1-5), the previous station is erased automatically. If you want to erase the station without adding a new one: while pressing ERASE, press the corresponding memory button (M1-M5). The frame around the memory number disappears which shows that memory has become vacant.

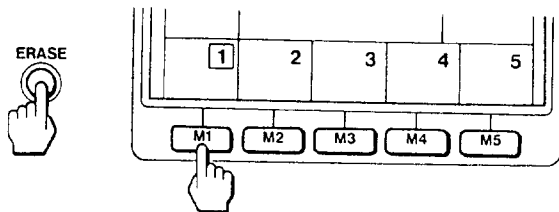

How to Tune in the Memorized Station

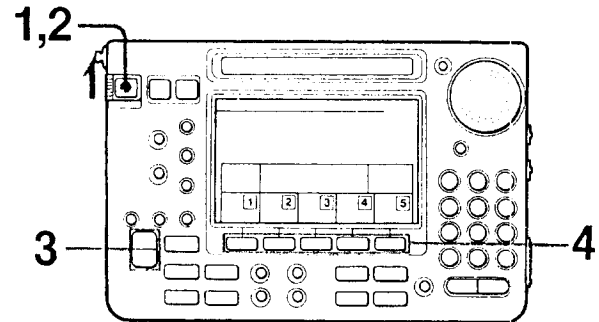

- 1 Set POWER/LOCK to POWER.
- 2 Press ON/OFF.
- 3 Press PAGE FEED + or - to select the page.
- 4 Press an M1 - M5 whose memory number is surrounded with in a frame.

When you go back to the latest page

Each time you press LAST PAGE, the number of the page previously memorized or received is displayed. In total, 8 pages are shown in this descending order. This button is convenient to use to go back to a station you often listen to.

Adding a Title in the Pages (1 – 25)

Titles can be added in each page from 1 to 25. You can also use the titles preset at the factory. In page "00", TIMER (M) label is already memorized and cannot be erased.

When using a title preset at the factory

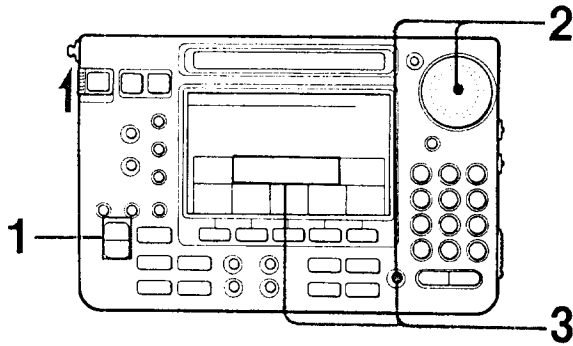

- 1 Press PAGE FEED + or – to select the page.
- 2 While pressing LABEL EDIT, turn the TUNE/JOG dial. Titles already preset appear in the display.
- 3 Release LABEL EDIT when you find the desired title. Now the title label is memorized.

The preset title labels are as follows:
 BBC, D-WELLE, R-BEIJIN, R-FRANCE, R-JAPAN, R-MOSCOW, VOA, APPOINTM (appointment), MEETING, TELEPHON (telephone)

Memorizing Stations

When adding your own title

You can make a title which has up to 8 characters. Letters, numerals or marks such as () / + – * are used. Freely think out your own titles such as JAZZ, POPS, NEWS, FM or AM according to the stations memorized in the same page.

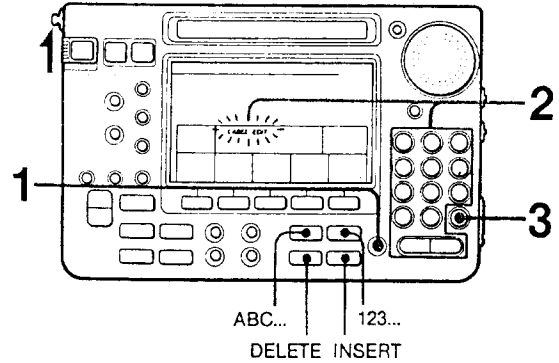

- 1 Press LABEL EDIT.
- 2 While the LABEL EDIT indication flashes, select the first character with the numeric/letter/mark buttons. Each time you select one character, press STEP/SCAN \leftarrow+, then move to the next character to be selected.
- 3 At the end of the title, press EXE. Now your own title label has been memorized.

Note

LABEL EDIT indication flashes for about 20 seconds after pressing any button. When no character is input during this period, the indication returns to the previous condition. In this case, press LABEL EDIT to try again.

To select the character to input

Numeric buttons work as letter buttons when the ABC... (FM) button is pressed and they return to numerals when the 123... (AM) button is pressed. One button comprises three letters. For example, if you press the button "1" continuously, the character changes from A → B → C and A.

To delete or add the character

- 1 Press LABEL EDIT.
- 2 Press STEP/SCAN - \leftarrow or \leftarrow+ to make the flashing move to the desired position.
- 3 To delete the flashing character, press DELETE (AM BAND +). To add a character, press INSERT (AM BAND -) to make a space and select the desired character.
- 4 Press EXE.

How to Set the Timer

You can set up to 5 different memories for timer operation. The memories are those preset in page "00". (See page 32.)

Before setting the timer, make sure that the desired station is memorized in the desired memory number. In page "00", if a frame does not appear around the desired memory number, see page 32 and memorize it.

Note

When you take longer than 20 seconds to proceed a step, the unit returns to the condition just before step 2. In this case, proceed again from step 2.

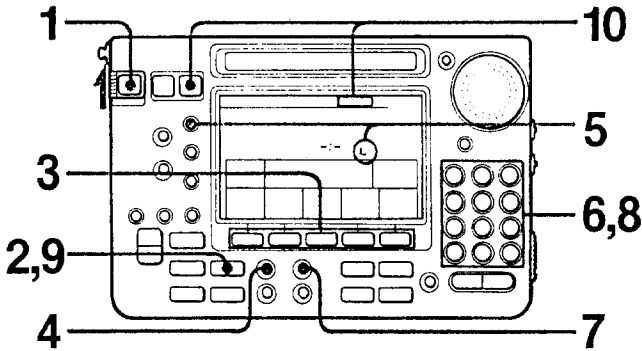

- 1 Set POWER/LOCK to POWER.
The ON/OFF button can be at either ON or OFF.
- 2 Press TIMER SET.
A frame appears around the memory number where the station is memorized in page "00".
The *TIMER* appears. The time itself and operation time appear when they have been already input. These are the memorized contents in the memory which ▲ points.
When nothing is memorized, - (minus) appears.

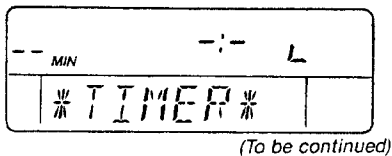

How to Set the Timer

(Continued)

- 3 Press the corresponding M1 to M5 button to place ▲ in the desired memory from 1 to 5. The memories 1-5 correspond to the broadcasting stations preset in page "00".
- 4 Press START TIME.
The START TIME indication flashes.
- 5 Check the L or U indication.



L: Timer will be set according to the local time.

U: Timer will be set according to UTC.

To change the indication, press the UTC/LOCAL button.

- 6 Input the timer-on time directly with the numeric buttons, ▲ button, numeric buttons and finally EXE.

Example

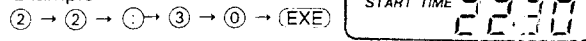

For a little further adjustment, while pressing the START TIME, turn the TUNE/JOG dial.

- 7 Press OPR TIME.
OPR TIME and MIN flash.
- 8 Input the time length of the timer operation in minutes (from 1 to 199 minutes) with the numeric buttons and finally press EXE.

Example 3 → 0 → (EXE)

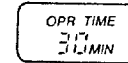

⊖ indication appears, but the timer is not completely prepared at this stage. Follow the next steps.

Time length can be also adjusted as follows: While pressing OPR TIME, turn the TUNE/JOG dial.

- 9 Press TIMER SET to quit the *TIMER* page.
- 10 Press STANDBY so that STANDBY indication appears.
When the STANDBY is already indicated, this step is not necessary.



Now the timer is set to activate. At the preset time, selected memory will start even when the power is turned off (but at least POWER/LOCK should be set at POWER) or when you are listening to another station.

Example

In page 00: station A is preset in memory "1"
 In memory "1" in *TIMER* page: the starting time is set at 23:30 and operation time is set for 90 minutes
 -- Station A will start at 23:30 and disconnect after 90 minutes.
 (Remaining time indication reduces from 90 MIN.)

Note on STANDBY button

The STANDBY button activates all the timer and alarm settings at once. After a setting has been completed by pressing the STANDBY button, all new settings in either the timer or alarm page are automatically activated when you quit the page. The (STANDBY) indication which appeared during the setting changes to STANDBY at that time and the unit enters the standby condition. If you press the STANDBY button again (in step 10), all the settings will be deactivated and the unit will not operate at the set time.

You should be accustomed to make sure the indication STANDBY when using timer or alarm!

What is ☺ mark?

This shows that the following three conditions are satisfied:

- A station is preset in that memory.
- Timer-on time is set.
- Timer operation time is set.

But this does not mean that the timer is set. Always make sure of the STANDBY indication after timer setting. When STANDBY indication does not appear, the timer will NOT activate.

How to Set the Timer

When two or more memories overlap, priority is transferred one and after to the memory whose timer-on time is the earliest.

Example

Memory 1 (station A is preset)
 Memory 2 (station B is preset)

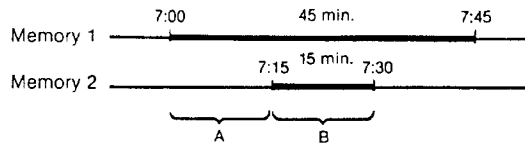

Station A starts at 7:00 and will be replaced with station B at 7:15 and station B will stop at 7:30. At that time, station A will not start again and the power will be disconnected.

Notes

- When you press TIMER SET while the STANDBY indication appears, the indication changes to (STANDBY). If the start time already set comes before you quit the *TIMER* page, the timer operation will be canceled. This also happens in alarm setting, in current time adjustment and in time difference adjustment. If start time comes during these operations, the timer operation will be canceled.
- When the timer activates, SLEEP indication and remaining time indication appear, and they disappear when the remaining time elapses.
- Sound volume of the radio activated by the timer, depends on the VOLUME control setting.

To Cancel the Timer Setting

Once you set the timer, the timer will activate at the same time everyday until you release it. To cancel the unnecessary timer operation on a particular day without completely erasing the setting, proceed as follows:

- 1 Set POWER/LOCK to POWER.
- 2 Press TIMER SET.
TIMER appears.
- 3 Press the M1 – M5 corresponding to the timer memory you don't need that day and press STANDBY.
The ☺ mark will disappear from the corresponding memory.
Pushing STANDBY again, resets the timer operation. The ☺ mark will come on again.
- 4 Press TIMER SET.

To Erase the Timer Setting Completely

Once you set the timer, the timer will activate everyday. To completely erase the timer setting, proceed as follows:

- 1 Set POWER/LOCK to POWER.
- 2 Press TIMER SET.
TIMER appears.
- 3 While pressing ERASE, press the corresponding M1 – M5 (regardless of the ▲ position).
The settings for start time and operation time in that memory will be cleared.
- 4 Press TIMER SET.

To Check the Station in Page "00" during Timer Setting

While pressing CHECK, press an M1 – M5 whose corresponding memory you want to know (a frame appears around the memory number). While CHECK is pressed, the frequency of the station preset in that memory is displayed.

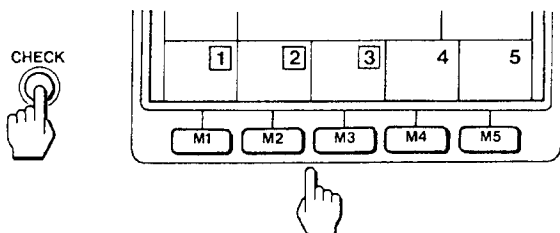

How to Set the Alarm

5 settings of the alarm will tell you the time by buzzer and/or indication.

Note

When you take longer time than 20 seconds to proceed a step, the unit returns to the condition just before step 2. In this case, proceed again from step 2.

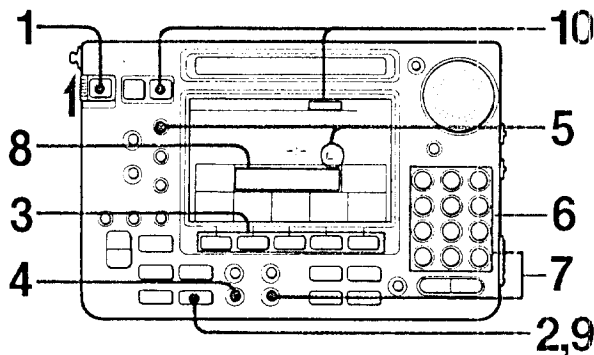

- 1 Set POWER/LOCK to POWER.
The ON/OFF button can be at either ON or OFF.
- 2 Press ALARM SET.
"AL" indication appears. The time itself and beep type appear when they have been already input. These are the memorized contents in the memory which "▲" points. When nothing is memorized, - (minus) appears.

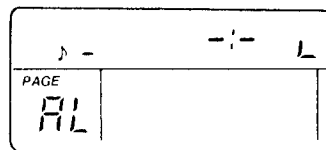

- 3 Select the memory with an M1 – M5.
The ▲ mark will move to the corresponding memory 1 – 5.
- 4 Press ALARM TIME.
START TIME indication flashes.
- 5 Check the L or U indication.
L: Alarm will be set according to the local time.
U: Alarm will be set according to the UTC.
To change the indication, press UTC/LOCAL button.
- 6 Input the alarm-on time.
Input the time directly with the numeric buttons, ⏸ button, numeric buttons and finally EXE.
For further adjustment, while pressing ALARM TIME, turn the TUNE/JOG dial.

- 7 Press BEEP TYPE and select the type of alarm sound with the numeric buttons and EXE. The trial beep will sound when pressing numeric buttons (except for the beep type 0).
 - Beep type 0 ... No sound but title will appear and Δ will flash to notify you without disturbing others.
 - Beep type 1–8 ... Beep sound will be heard once to 8 times.
 - Beep type 9 ... Wake-up beep will sound.
- Now Δ appears in the selected memory. Beep type can be also selected as follows: While pressing BEEP TYPE, turn the TUNE/JOG dial to select from 0 to 9. The trial beep will sound when BEEP TYPE is released (except for the beep type 0).
- 8 Enter the alarm title for each memory in the same way as for title editing on page 43, if necessary. The alarm is not completely set at this stage. Follow the next steps.
 - 9 Press ALARM SET to quit the alarm page. "AL" indication disappears.
 - 10 Press STANDBY so that STANDBY indication appears. If STANDBY has been already indicated, this step is not necessary.

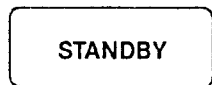

Now the alarm is set to activate.

At the time set, buzzer sound will be heard and the Δ mark in the selected memory will flash. The display will be illuminated for about 15 seconds.

The title will continue to be displayed for about 1 hour. To make the title disappear, press any button. (If \rightarrow is displayed, press KEY PROTECT and then press any other button.)

Wake-up beep (beep type 9) will continue for about 1 hour. To stop the beep, press any button.

Note on STANDBY button

The STANDBY button activates all the timer and alarm settings at once. After a setting has been completed by pressing the STANDBY button, all new settings in either the timer or alarm page are automatically activated when you quit the page. See page 43 for details.

How to Set the Alarm

To Cancel the Alarm Setting

Once you set the alarm, the alarm will activate at the same time everyday until you release it. To cancel the unnecessary alarm operation on a particular day without completely erasing the setting, proceed as follows:

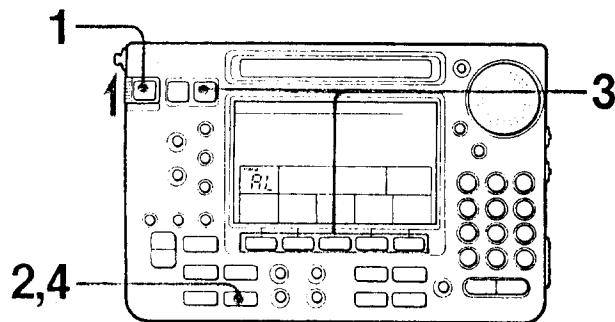

- 1 Set POWER/LOCK to POWER.
- 2 Press ALARM SET.
- 3 Press the M1–M5 button corresponding to the alarm memory you don't need that day and press STANDBY. The Δ mark will disappear from the corresponding memory. Pushing STANDBY again, resets the alarm operation. The Δ mark will come on again.
- 4 Press ALARM SET.

Sleep Timer Operation

To Erase the Alarm Completely

Once you set the alarm, the alarm will activate everyday.
To completely erase the alarm setting, proceed as follows:

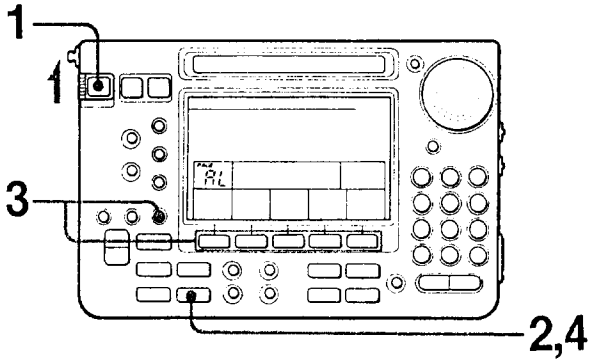

- 1 Set POWER/LOCK to POWER.
- 2 Press ALARM SET.
"AL" appears.
- 3 While pressing ERASE, press M1 – M5 (regardless of the ▲ position) of the alarm memory you want to cancel.
The settings for alarm time and beep type in that memory will be cleared. (Title label will remain.)
- 4 Press ALARM SET.

You can fall asleep while listening to the radio.

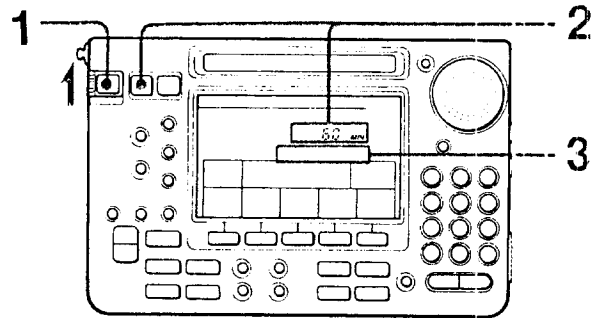

- 1 Set POWER/LOCK to POWER.
The ON/OFF can be at either ON or OFF.
- 2 Press SLEEP until desired time length of timer is displayed.
It changes from 60 → 45 → 30 → 15 minutes.
- 3 Tune in the desired station and adjust the volume.
The radio will be turned off automatically after the time set.

To turn off the radio before the time being set

Press ON/OFF, or press SLEEP until the UTC time difference is displayed.

When setting both sleep timer and alarm

You can fall asleep listening to the radio and wake up by the alarm.

SECTION 2 DISASSEMBLY

Note: Follow the disassembly procedure in the numerical order given.

2-1. Removal Rear Cabinet

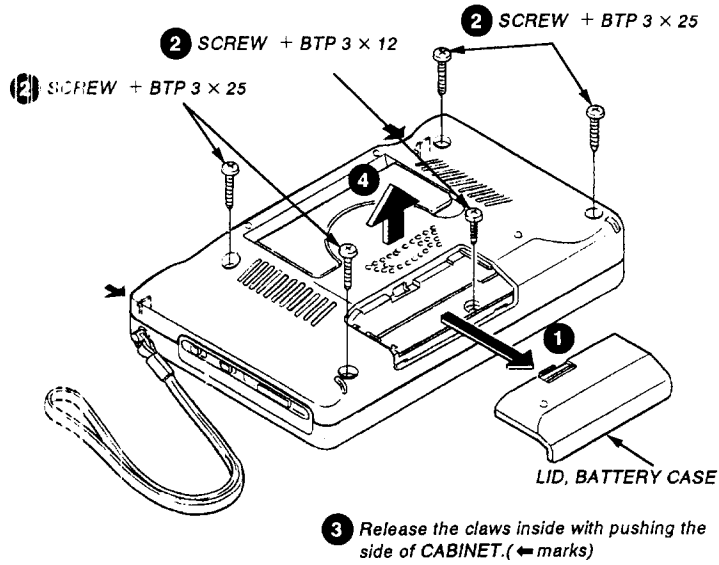

2-2. Removal LCD

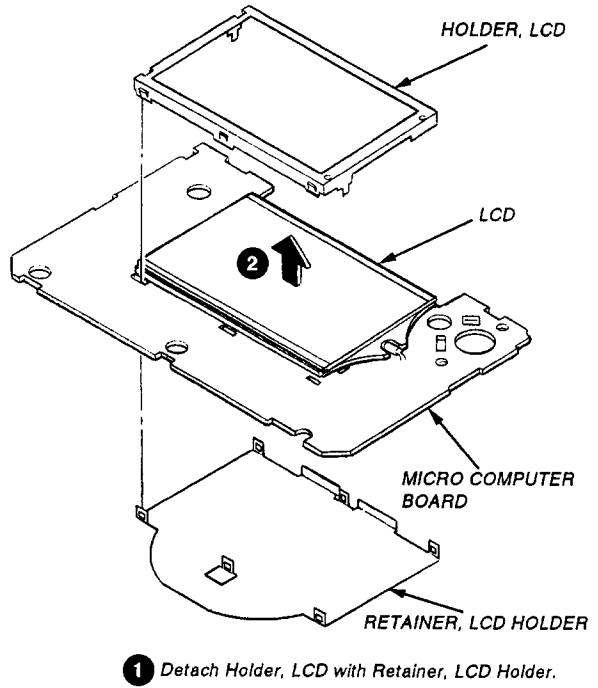

2-3. Removal Key Board

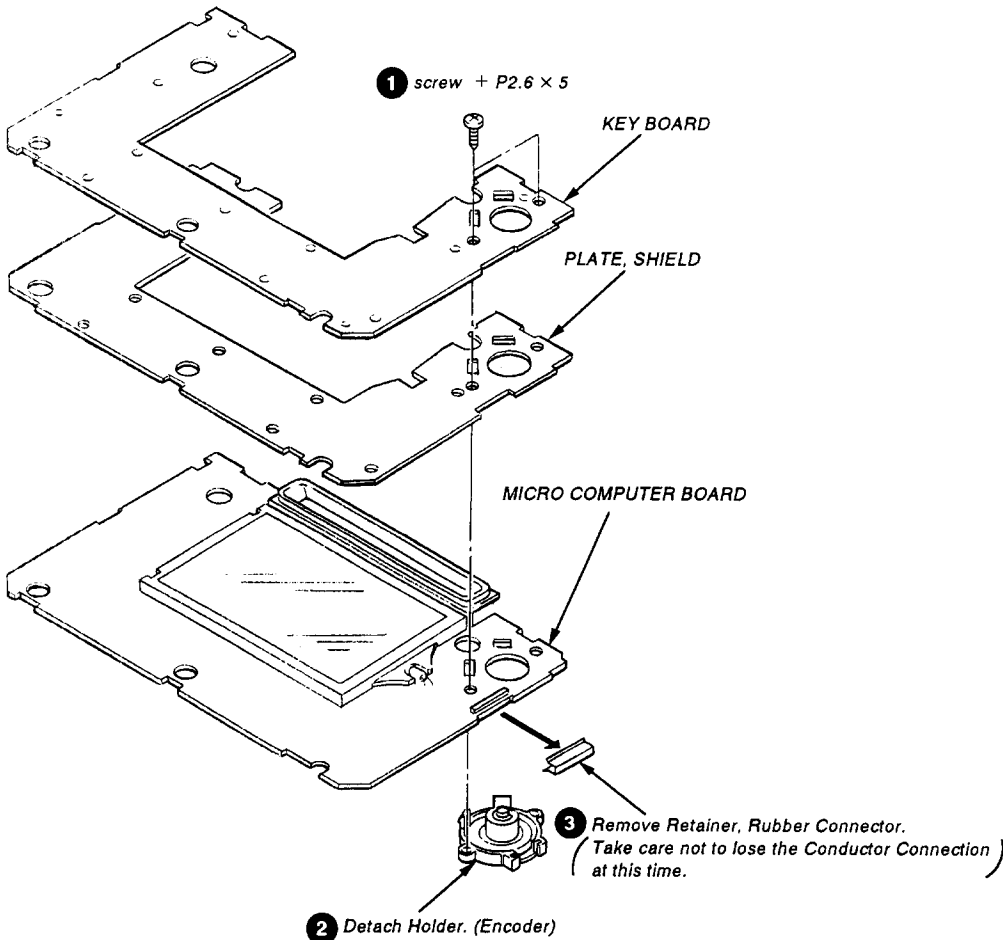

SECTION 3 PORT FUNCTIONS DISCRIPTION

IC904, 905 M6M80021FP

Pin No.	Symbol	Name	Description
1	\overline{CS}	CHIP SELECT IN	<ul style="list-style-type: none"> • Selects chip at "L". In case the terminal is at "H", resets built-in sequential controller. For this reason, set this terminal at "H" once before performing on action in a mode. • In performing of writing in (when busy output is at "L"), it continves to write in despite this terminal is performing input action. • After performed write in, after this terminal is turned to "H" . However in case of "status output" only, write in is feasible when sequence controller is reset and then this terminal remains at "L" after write in started.
2	\overline{SCK}	CLOCK IN	<ul style="list-style-type: none"> • Reads in input data at rising up edge of the clock. • Data outputs synchronously at falling down of the clock.
3, 8	NC	NO CONNECTION	This is a free terminal and is not connected to the internal circuits, and this terminal can be used as a junction land.
4	DI	DATA IN	Input data.
5	\overline{DO}	DATA OUT	Output data. DI can be connected with \overline{DO} .
6	V _{SS}	GROUND	Ground-return terminal.
7	RESET	RESET IN	<ul style="list-style-type: none"> • Set to "H" at the time of power ON/OFF. • When set to "H" , sequential controller and write in circuit are reset and performing memory protection. During writing in, the write in is interrupted when this terminal becomes to "H". • Furthermore, RESET and \overline{CS} are connectable. However, at such time, during writing in, \overline{CS} (=RESET) is required to maintain at "L".
9	RDY/ \overline{BUSY}	BUSY OUT	<ul style="list-style-type: none"> • Turns to "L" during performance of write in. • Turns to "L" at the time of power ON/OFF. At this time, writing in of all inputs are prohibited.
10	V _{DD}	INPUT OF POWER SUPPLY VOLTAGE	Power supply terminal (+5V).

SECTION 4 ELECTRICAL ADJUSTMENT

Preparation

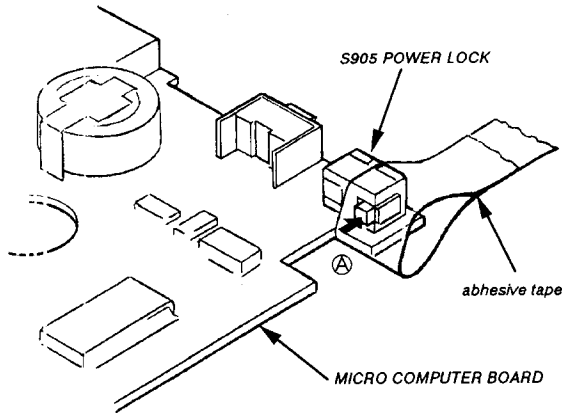

How to turn the power ON/OFF

1. Press down portion ① of S905 (Power Lock) switch by adhesive tape.
2. Press the S148 (ON/OFF) switch on the KEY Board.

AM SECTION

2nd LOCAL ADJUSTMENT

Setup:

VOLUME control: Arbitrary
STEREO/MONO: STEREO
AM SENS: NORM

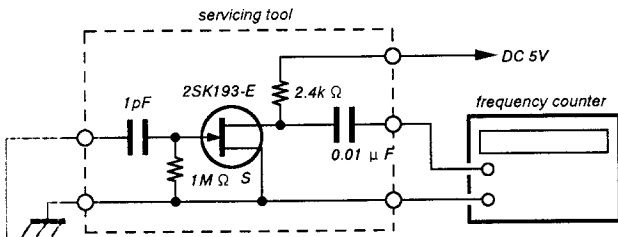

[SIGNAL BOARD] (CONDUCTOR SIDE)

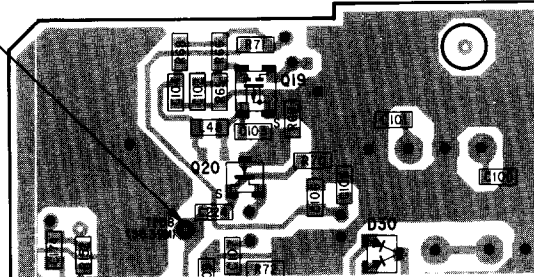

Procedure:

1. Tune the set to AM 150kHz.
2. Adjust T13 to obtain a 55.3912 ± 0.0003 MHz on the frequency counter.

BFO ADJUSTMENT

Setup:

VOLUME control: Arbitrary
STEREO/MONO: STEREO
AM SENS: NORM

[SIGNAL BOARD]
(CONDUCTOR SIDE)

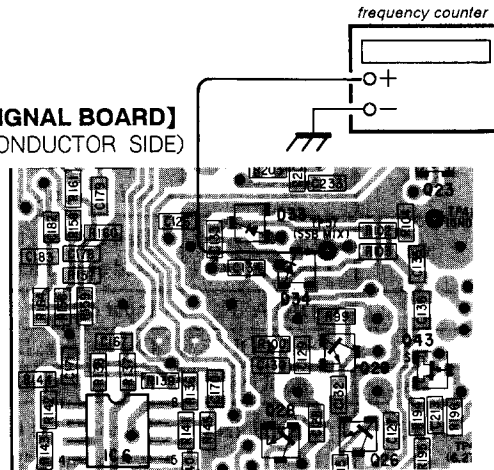

Procedure:

• BFO (USB) ADJUSTMENT

1. Tune the set to AM 150kHz USB.
2. Adjust CT1 to obtain a 457 ± 0.05 kHz on the frequency counter.

• BFO (LSB) ADJUSTMENT

1. Tune the set to AM 150kHz LSB.
2. Adjust CT2 to obtain a 453 ± 0.05 kHz on the frequency counter.

PLL ADJUSTMENT

Setup:

VOLUME control: Arbitrary
STEREO/MONO: STEREO

[SIGNAL BOARD]
(CONDUCTOR SIDE)

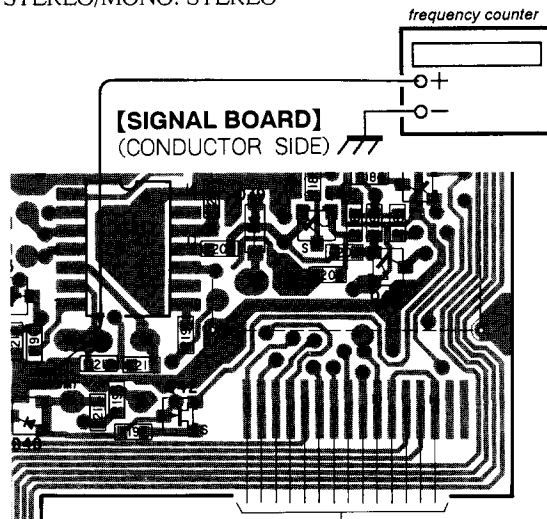

Procedure:

1. Tune the set to AM 4155kHz W1 DE.
2. Adjust CT6 to obtain a 60 ± 0.0005 MHz on the frequency counter.

AM IF ADJUSTMENT

Setup:

VOLUME control: Arbitrary
STEREO/MONO: STEREO

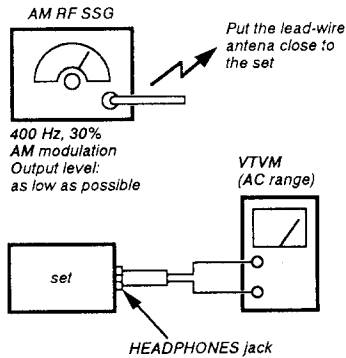

Procedure:

1. Tune the set to the AM RF SSG frequency.
2. Adjust T4 and T5 for a maximum output level.
3. Final response should be as illustrated below.

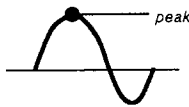

FM SECTION

FM VCO ADJUSTMENT

Setup:

VOLUME control: Arbitrary

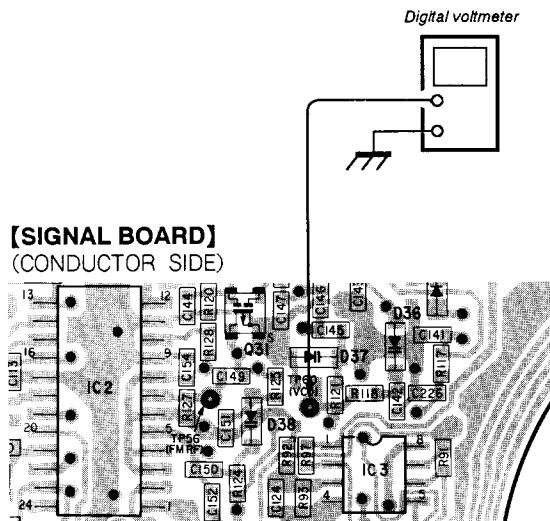

Procedure:

1. Tune the set to 76MHz.
2. Adjust T11 to obtain a $1.8 \pm 0.1V$ on the Digital voltmeter.

FM RF ADJUSTMENT

Setup:

VOLUME control: Arbitrary
AM SENS: DX

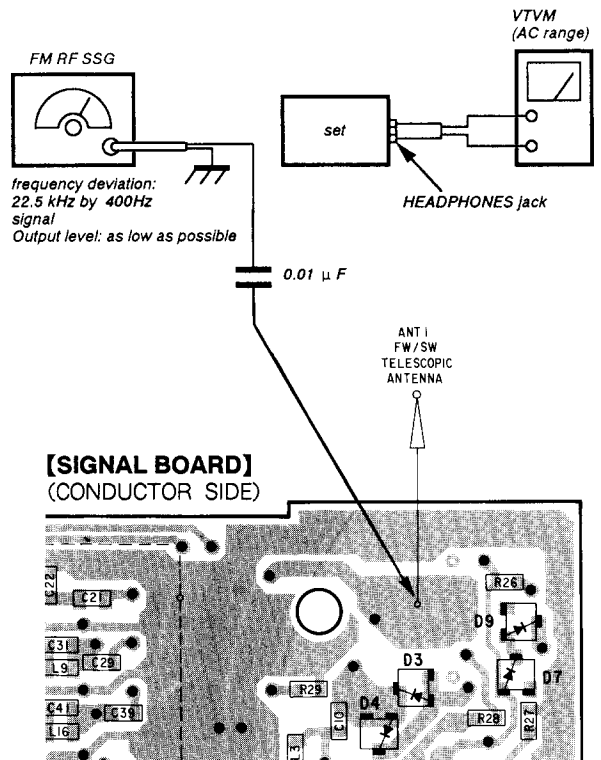

Procedure:

1. Set the frequencies of the FM RF SSG and the frequency display of the set to 76MHz.
2. Adjust T9 and T10 to obtain a maximum reading on the VTVM.
3. Set the frequencies of the FM RF SSG and the frequency display of the set to 108MHz.
4. Adjust CT3 and CT4 to obtain a maximum reading on the VTVM.
5. Repeat the above steps several times.

FM STEREO ADJUSTMENT

Setup:

VOLUME control: Arbitrary

[SIGNAL BOARD] (CONDUCTOR SIDE)

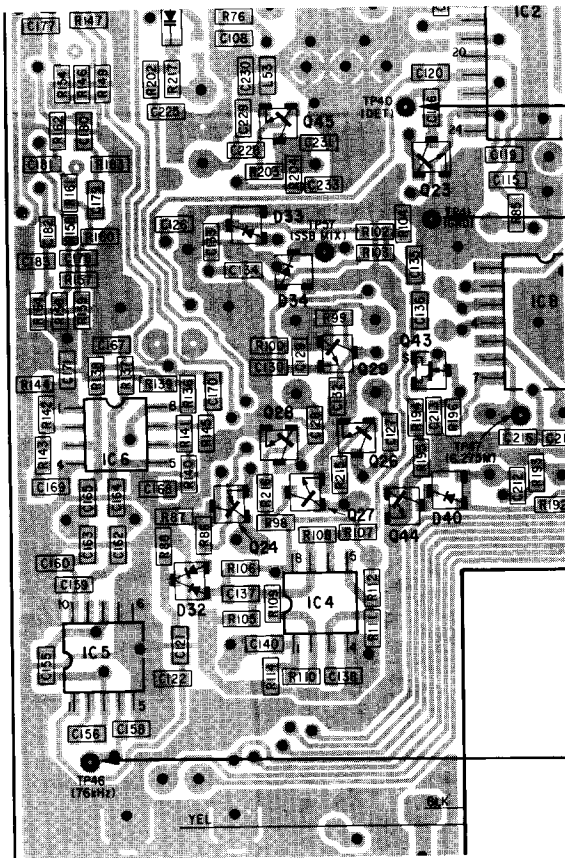

Procedure:

1. Insert HEADPHONES plug into HEADPHONES jack.
2. Connect a capacitor (10 μF) between pin ② of IC2 and GROUND.
3. Set frequency display of the set to 93MHz.
4. Adjust RV1 to obtain 76MHz ± 500Hz on the frequency counter.

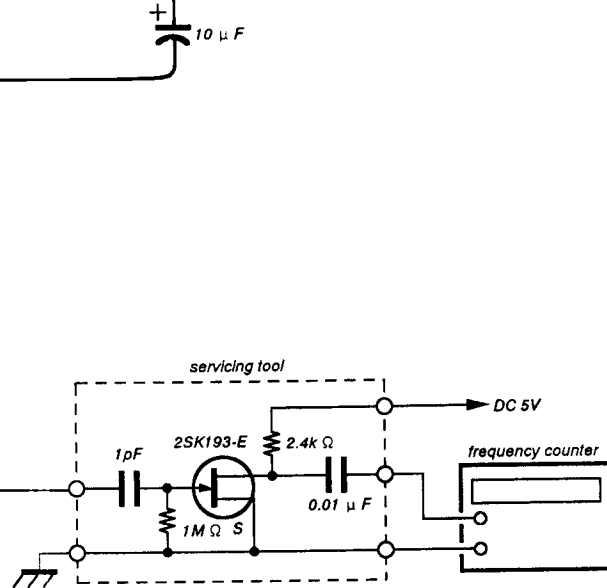

[SIGNAL BOARD] (COMPONENT SIDE)

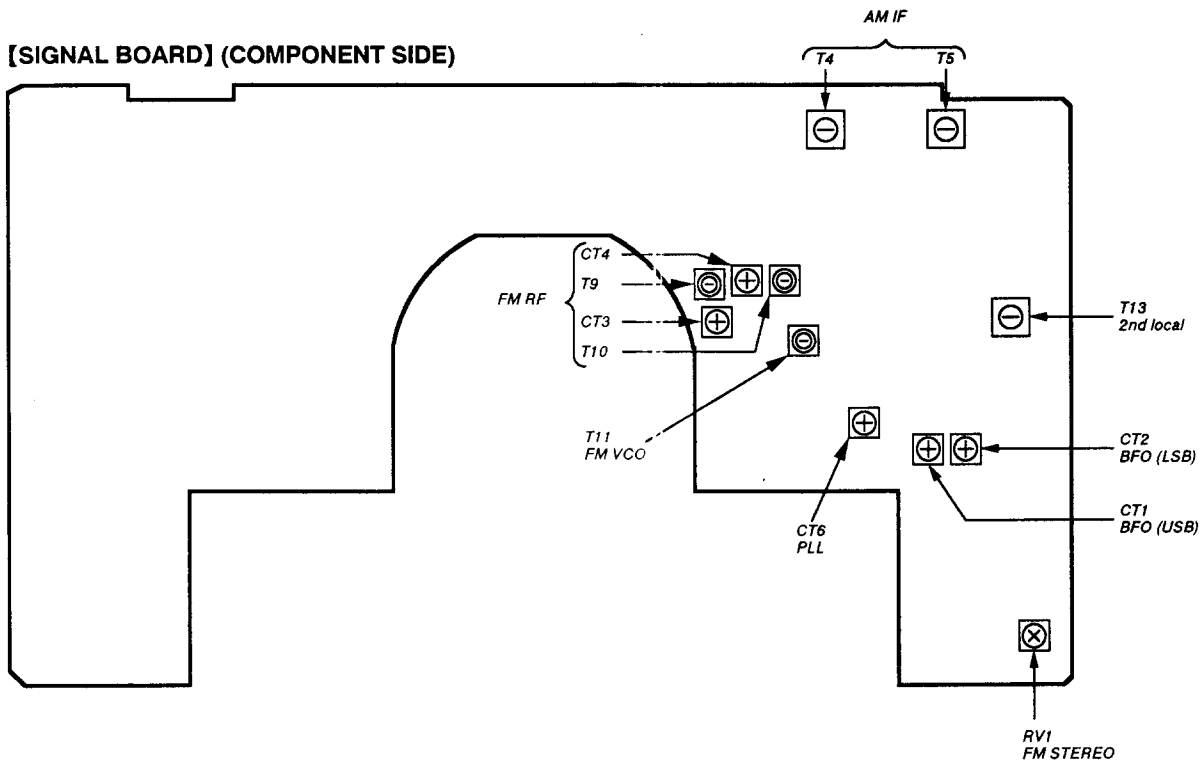

•Semiconductor lead Layout

μ PD7225GB-3B7

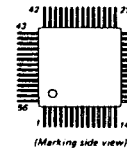

3SK-132A-U35

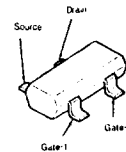

1SS279
1T-33

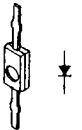

μ PD75316GF-181
μ PD75316GF-3B9

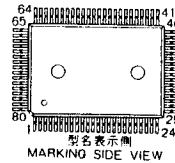

1MN10

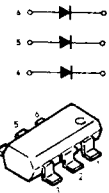

LT120

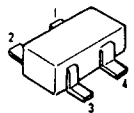

- 1. GND
- 2. Input
- 3. Vcc
- 4. Output

μ PD75328GC-522
μ PD75328GC-3B9

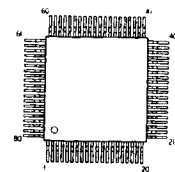

1MN11

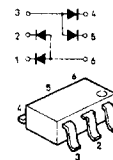

Note :

- All capacitors are in μF unless otherwise noted. pF: $\mu \mu F$
50WV or less are not indicated except for electrolytics and tantalums.
- All resistors are in Ω and $\frac{1}{4}W$ or less unless otherwise specified.

• Δ : internal component.

• $\boxed{B+}$: B+ Line

• $\boxed{}$: adjustment for resistor

•IC Block Diagrams.

IC1 74HC138ANS

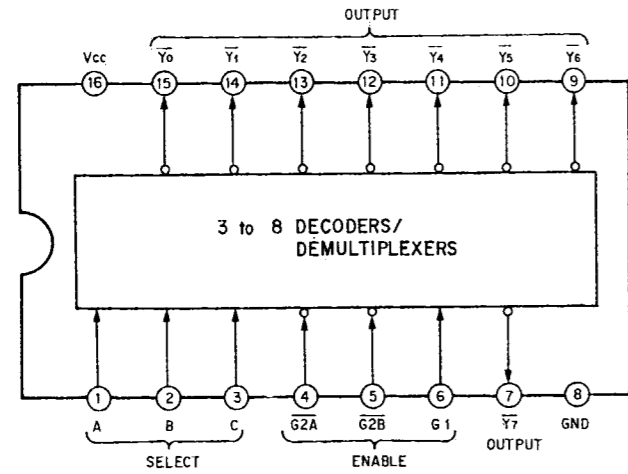

IC2 CXA20111

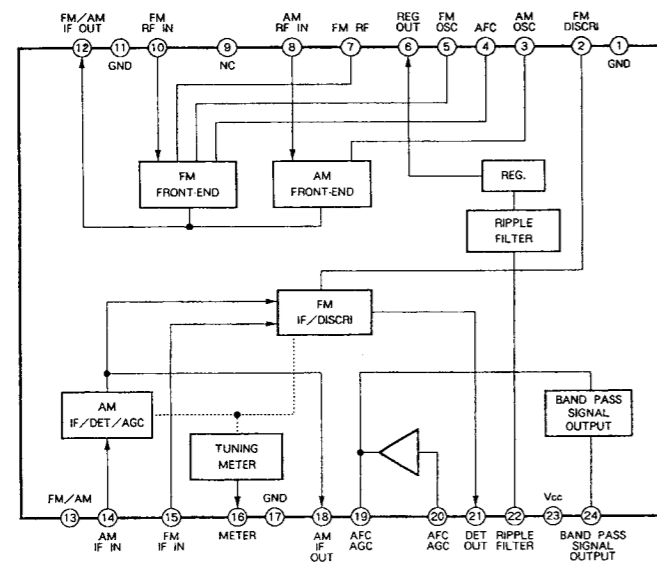

IC3, 4, 6 LM358DR

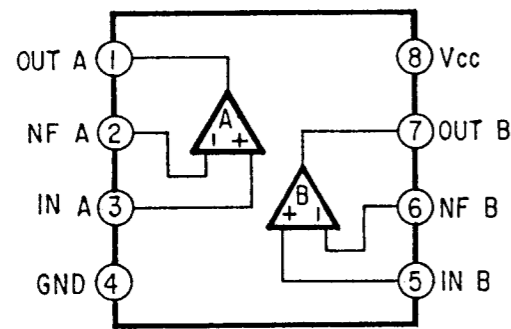

IC5 LA3335M

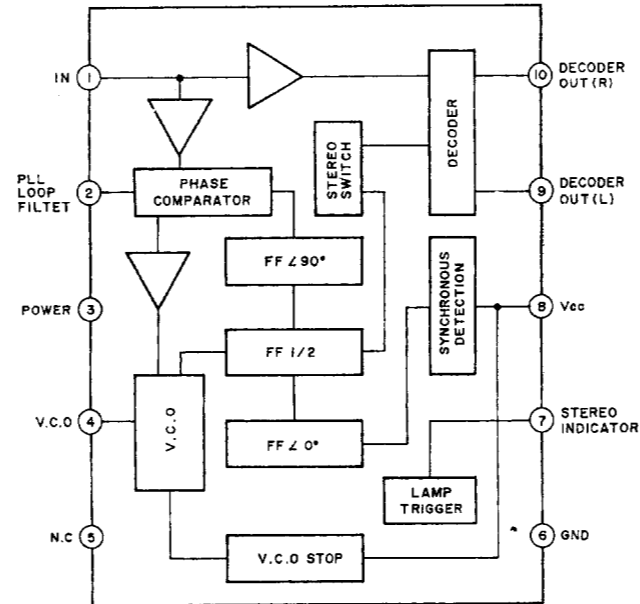

IC7 UPC1316C

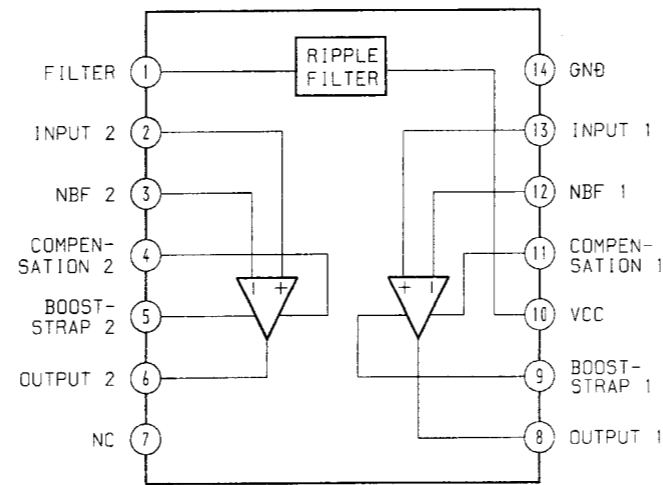

IC8 CXD1118M

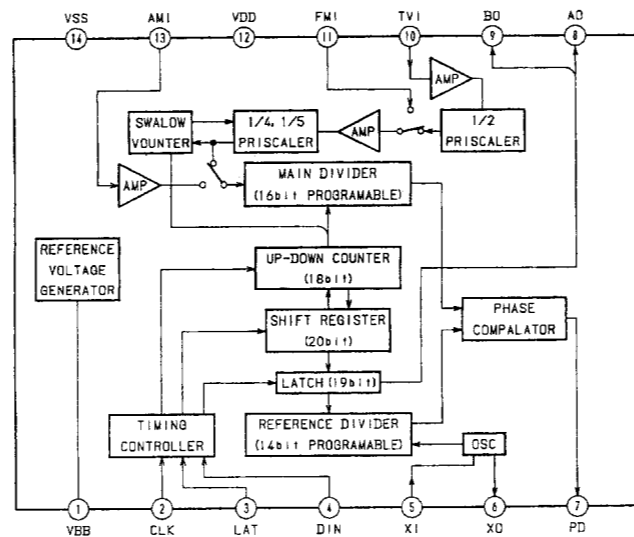

IC10 LA5003M

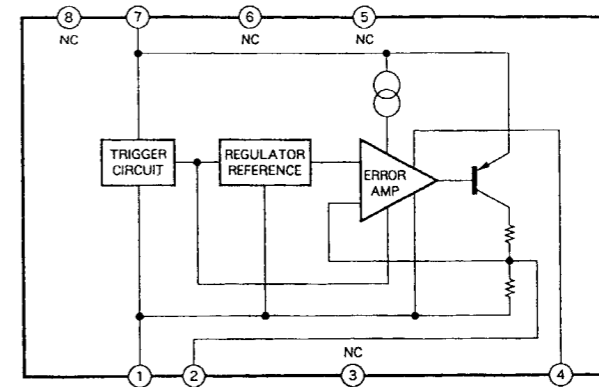

IC903 μ PD7225GB-3B7

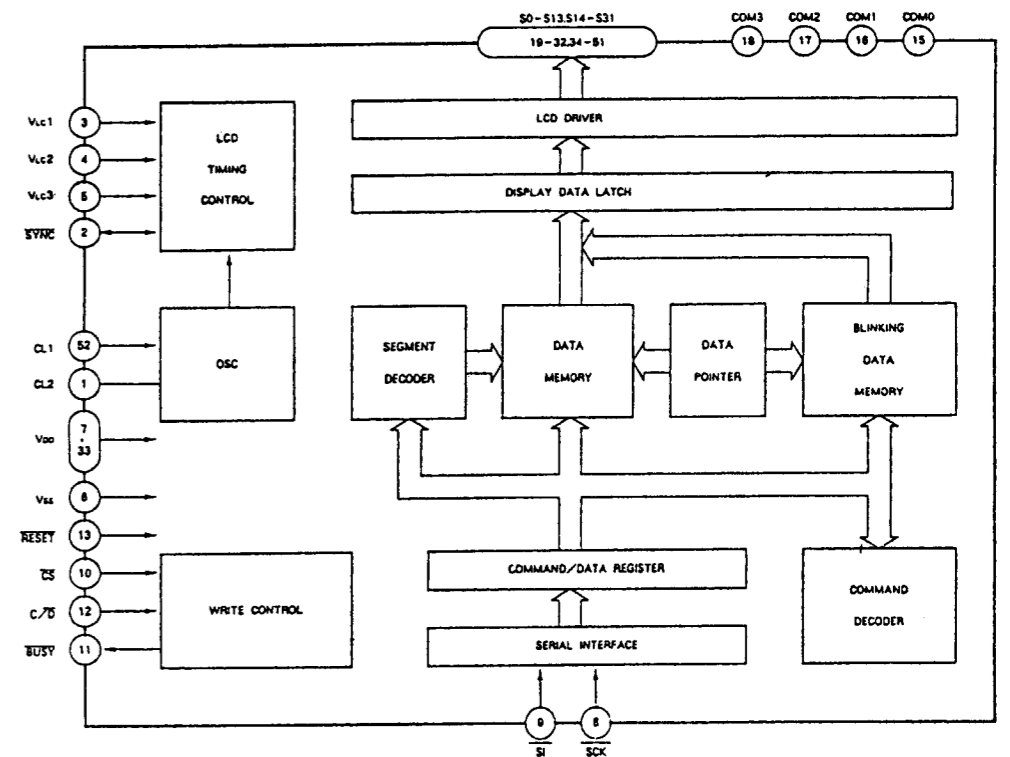

6-1. FRONT CABINET SECTION

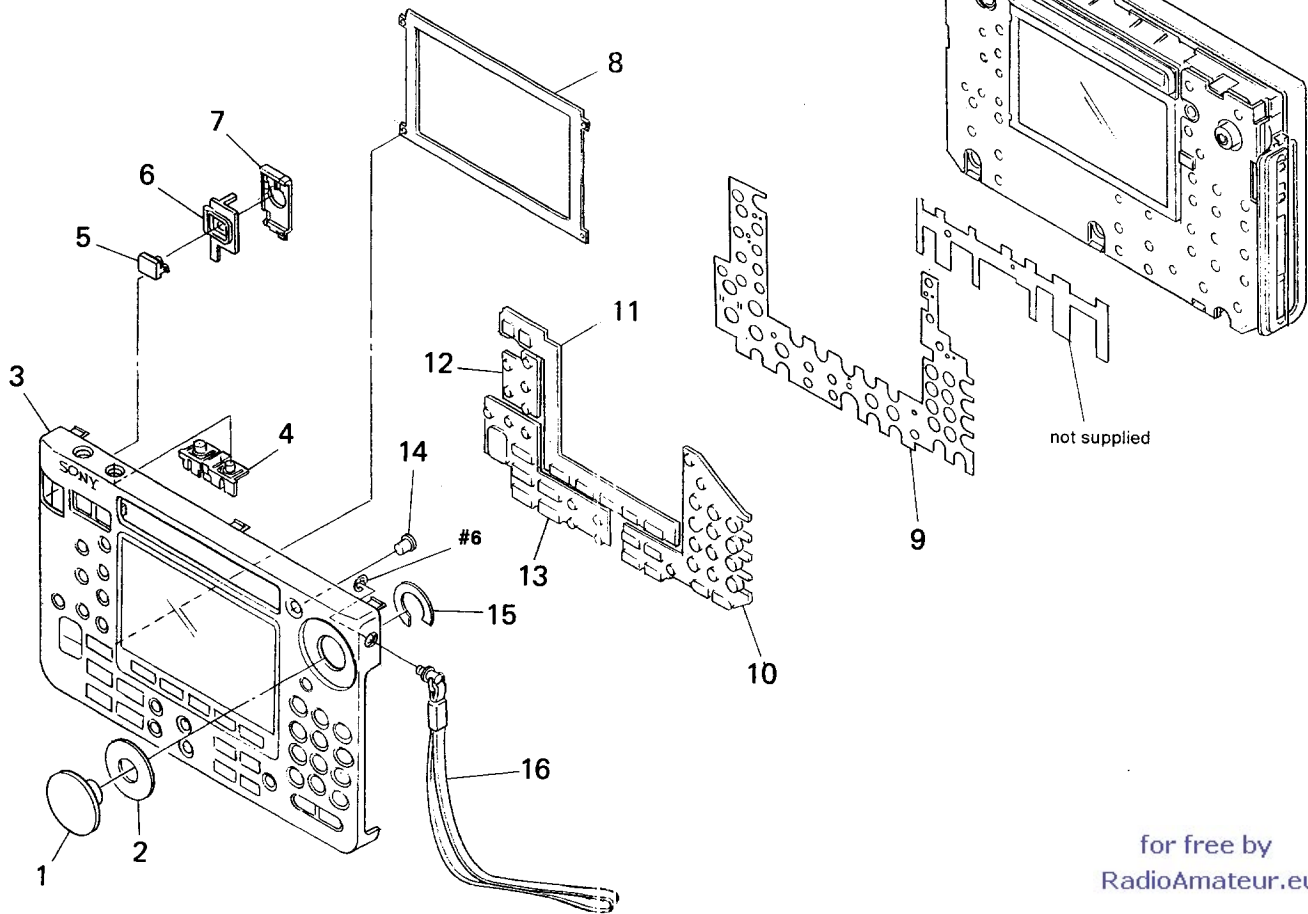

6-2. CHASSIS SECTION

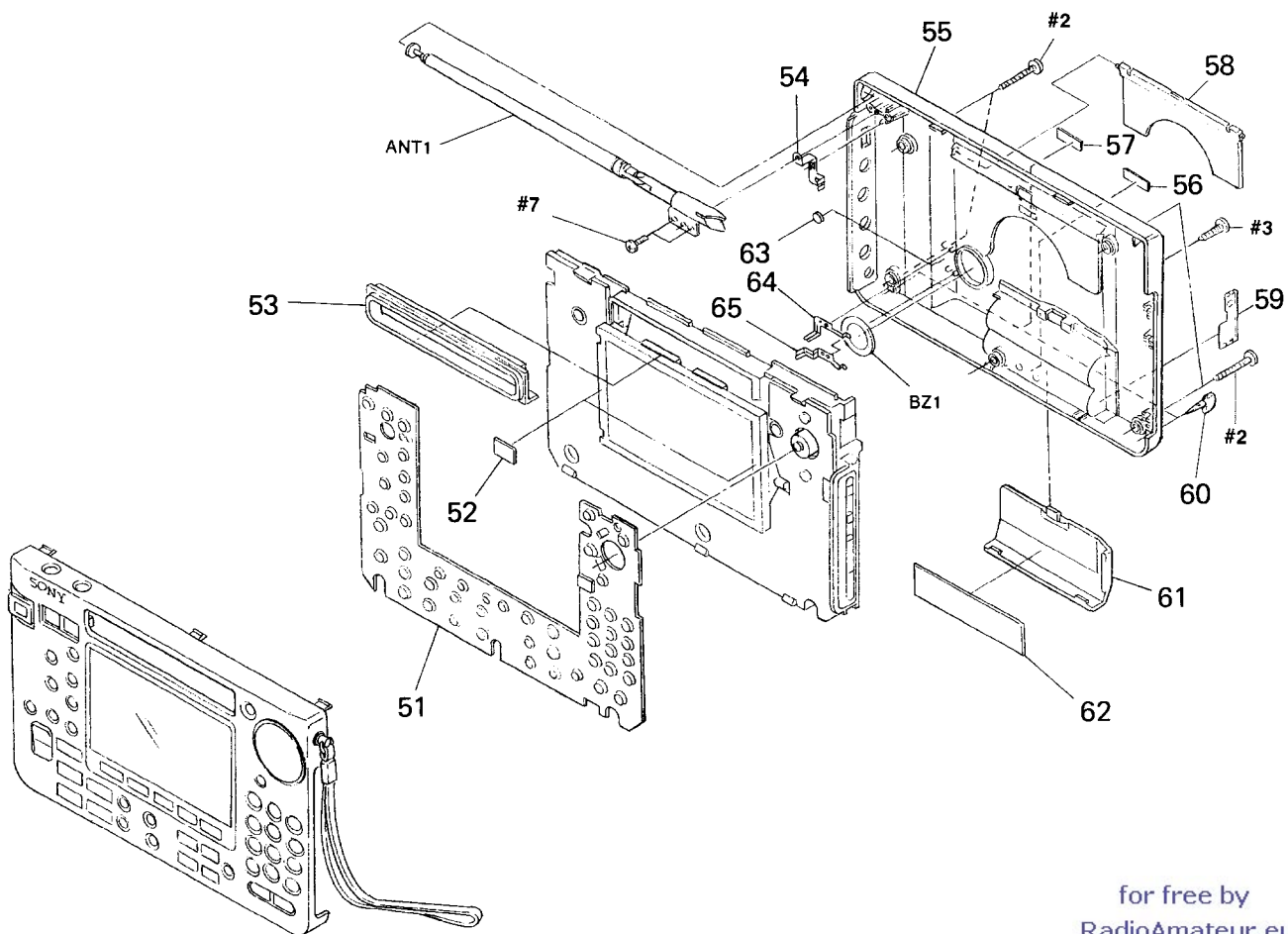

6-3. LCD SECTION

